



Newland AIDC
Scanning Made Simple



Wireless 2D Barcode Scanner

NLS-HR3000-BT

**User
Guide**

Disclaimer

© 2024 Fujian Newland Auto-ID Tech. Co., Ltd. All rights reserved.

Please read through the manual carefully before using the product and operate it according to the manual. It is advised that you should keep this manual for future reference.

Do not disassemble the device or remove the seal label from the device, doing so will void the product warranty provided by Fujian Newland Auto-ID Tech. Co., Ltd.

All pictures in this manual are for reference only and actual product may differ. Regarding to the product modification and update, Fujian Newland Auto-ID Tech. Co., Ltd. reserves the right to make changes to any software or hardware to improve reliability, function, or design at any time without notice. The information contained herein is subject to change without prior notice.

The products depicted in this manual may include software copyrighted by Fujian Newland Auto-ID Tech. Co., Ltd or third party. The user, corporation or individual, shall not duplicate, in whole or in part, distribute, modify, decompile, disassemble, decode, reverse engineer, rent, transfer or sublicense such software without prior written consent from the copyright holders.

This manual is copyrighted. No part of this publication may be reproduced, distributed or used in any form without written permission from Newland.

Fujian Newland Auto-ID Tech. Co., Ltd. reserves the right to make final interpretation of the statement above.

Fujian Newland Auto-ID Tech. Co., Ltd.

No.1, Rujiang West Rd., Mawei, Fuzhou, Fujian, China 350015

<http://www.newlandaidc.com>

Revision History

Version	Description	Date
V1.0.0	Initial release.	July 15 th , 2024

Table of Contents

Revision History	3
Preface	1
Introduction	1
Chapter Description	1
Explanation of Icons	2
Chapter 1 Getting Started	3
Introduction	3
Features of the HR3000-BT	3
Unpacking	3
The Scanner	4
Dimensions of the Scanner (unit: mm)	5
HCD20 Cradle	6
Connecting the Cradle to a Host	7
Using USB Cable	7
Pairing the Scanner to a Cradle	8
Power On, Power Off, Reboot	8
Chapter 2 Easyset	9
Chapter 3 System Setting	10
Introduction	10
Barcode Programming	10
Command Programming	10
EasySet Programming	10
Programming Barcode/ Programming Command/Function	11
Use of Programming Command	12
Use of Programming Barcodes	12
Illumination	13
Aiming	13
Good Read LED	14
Good Read LED Duration	14
Power On Beep	15
Good Read Beep	15
Good Read Beep Duration	16
Good Read Beep Frequency	17

Good Read Beep Volume	18
Remind Beep Volume	19
Scan Mode	20
Decode Session Timeout	21
Image Stabilization Timeout (Sense Mode).....	22
Reread Timeout	23
Image Decoding Timeout	24
Image Decoding Preference.....	25
Sensitivity (Sense Mode)	26
Scanning Preference.....	27
BEL Character Beep	28
Surround GS1 Application Identifiers (AIs) with Parentheses	29
Output GS1 Application Identifiers (AIs).....	30
GS1 Composite.....	31
GS1 Databar(RSS)	31
GS1 QR	31
GS1 Data Matrix	32
Transmit GS1 Check Character	33
Read Barcode On/Off.....	34
Smart Stand Mode	34
Decode Area	35
Image Flipping.....	39
Bad Read Message.....	40
Set Bad Read Message	40
Power Off	41
Default Settings.....	41
Factory Defaults.....	41
Custom Defaults	41
Query Scanner Information	42
Query Product Name	42
Query Firmware Version	42
Query Decoder Version.....	42
Query Data Formatter Version	43
Query Hardware Version.....	43
Query Serial Number	43
Query OEM Serial Number	43
Chapter 4 Wireless Communication	44

Bluetooth HID	44
Bluetooth BLE	44
Bluetooth Dongle KBW	44
USB Country Keyboard Types	45
Beep on Unknown Character	49
Emulate ALT+Keypad	50
Function Key Mapping	54
ASCII Function Key Mapping Table	55
ASCII Function Key Mapping Table (Continued)	56
Inter-Keystroke Delay.....	57
Caps Lock	57
Convert Case	58
Emulate Numeric Keypad	59
Fast Mode	62
Polling Rate.....	63
Bluetooth Dongle CDC	65
Bluetooth Dongle HID POS (POS HID Barcode Scanner)	66
Introduction	66
Access the Scanner with Your Program.....	66
Acquire Scanned Data	67
Send Command to the Scanner.....	67
VID/PID	68
Default Setting of Wireless Communication	69
Clear Pairing Information of Scanner	69
Operating Modes.....	70
Batch Mode.....	71
Batch Mode Options	71
Prevent Same Barcode Storage	72
Batch Mode Transmit Delay.....	73
End of Transmission Message for Batch Mode.....	74
Transmit Stored Data	75
Auto Clear Stored Data after Transmission.....	75
Query/Clear Stored Data in Flash	75
Auto Power-Off Timeout.....	76
Set Scanner Name	77
Set Date and Time	78
Query Current Date and Time	78

Query Battery Status	79
Time Stamp.....	79
Set Time Stamp Format	80
Chapter 5 Symbologies.....	81
Introduction	81
Global Settings.....	81
Enable/Disable All Symbologies	81
Enable/Disable 1D Symbologies.....	81
Enable/Disable 2D Symbologies.....	82
Enable/Disable Postal Symbologies	82
Code 128	83
Restore Factory Defaults	83
Enable/Disable Code 128	83
Set Length Range for Code 128	84
EAN-8	85
Restore Factory Defaults	85
Enable/Disable EAN-8	85
Transmit Check Character	85
2-Digit Add-On Code.....	86
5-Digit Add-On Code.....	87
Add-On Code Required.....	88
Convert EAN-8 to EAN-13	88
EAN-13	89
Restore Factory Defaults	89
Enable/Disable EAN-13.....	89
Transmit Check Character	90
2-Digit Add-On Code.....	90
5-Digit Add-On Code.....	91
Add-On Code Required.....	91
EAN-13 Beginning with 290 Add-On Code Required	92
EAN-13 Beginning with 378/379 Add-On Code Required	92
EAN-13 Beginning with 414/419 Add-On Code Required	93
EAN-13 Beginning with 434/439 Add-On Code Required	93
EAN-13 Beginning with 977 Add-On Code Required.....	94
EAN-13 Beginning with 978 Add-On Code Required.....	94
EAN-13 Beginning with 979 Add-On Code Required.....	95
UPC-E	96

Restore Factory Defaults	96
Enable/Disable UPC-E.....	96
Enable/Disable UPC-E0.....	97
Enable/Disable UPC-E1	97
Transmit Check Character	98
2-Digit Add-On Code.....	98
5-Digit Add-On Code.....	99
Add-On Code Required.....	100
Transmit Preamble Character	100
Convert UPC-E to UPC-A	101
UPC-A.....	102
Restore Factory Defaults	102
Enable/Disable UPC-A.....	102
Transmit Check Character	103
2-Digit Add-On Code.....	104
5-Digit Add-On Code.....	105
Add-On Code Required.....	106
Transmit Preamble Character	106
Coupon	107
UPC-A/EAN-13 with Extended Coupon Code.....	107
Coupon GS1 Databar Output.....	108
Interleaved 2 of 5	109
Restore Factory Defaults	109
Enable/Disable Interleaved 2 of 5	109
Set Length Range for Interleaved 2 of 5	110
Safety Level	111
Check Character Verification	112
Febraban.....	113
Disable/Enable Febraban.....	113
Transmit Delay per Character	113
Transmit Delay per 12 Characters	116
ITF-14	118
Restore Factory Defaults	118
Enable/Disable ITF-14	118
ITF-6	119
Restore Factory Defaults	119
Enable/Disable ITF-6	119

Matrix 2 of 5	120
Restore Factory Defaults	120
Enable/Disable Matrix 2 of 5	120
Set Length Range for Matrix 2 of 5	121
Check Character Verification	122
Code 39	123
Restore Factory Defaults	123
Enable/Disable Code 39	123
Set Length Range for Code 39	124
Check Character Verification	125
Transmit Start/Stop Character	126
Enable/Disable Code 39 Full ASCII	126
Enable/Disable Code 32 (Italian Pharma Code)	127
Code 32 Prefix	127
Transmit Code 32 Start/Stop Character	128
Transmit Code 32 Check Character	128
Codabar	129
Restore Factory Defaults	129
Enable/Disable Codabar	129
Set Length Range for Codabar	130
Check Character Verification	131
Start/Stop Character	132
Code 93	133
Restore Factory Defaults	133
Enable/Disable Code 93	133
Set Length Range for Code 93	134
Check Character Verification	135
China Post 25.....	136
Restore Factory Defaults	136
Enable/Disable China Post 25	136
Set Length Range for China Post 25	137
Check Character Verification	138
GS1-128 (UCC/EAN-128)	139
Restore Factory Defaults	139
Enable/Disable GS1-128.....	139
Set Length Range for GS1-128.....	140
GS1 Databar (RSS)	141

Restore Factory Defaults	141
Enable/Disable GS1 Databar	141
Transmit Application Identifier "01"	141
GS1 Composite (EAN-UCC Composite)	142
Restore Factory Defaults	142
Enable/Disable GS1 Composite.....	142
Enable/Disable UPC/EAN Composite	142
Code 11	143
Restore Factory Defaults	143
Enable/Disable Code 11	143
Set Length Range for Code 11	144
Check Character Verification	145
Transmit Check Character	146
ISBN.....	147
Restore Factory Defaults	147
Enable/Disable ISBN	147
Set ISBN Format.....	148
ISSN.....	149
Restore Factory Defaults	149
Enable/Disable ISSN	149
Industrial 25.....	150
Restore Factory Defaults	150
Enable/Disable Industrial 25	150
Set Length Range for Industrial 25	151
Check Character Verification	152
Standard 25.....	153
Restore Factory Defaults	153
Enable/Disable Standard 25	153
Set Length Range for Standard 25	154
Check Character Verification	155
Plessey	156
Restore Factory Defaults	156
Enable/Disable Plessey	156
Set Length Range for Plessey	157
Check Character Verification	158
MSI-Plessey.....	159
Restore Factory Defaults	159

Enable/Disable MSI-Plessey.....	159
Set Length Range for MSI-Plessey.....	160
Check Character Verification	161
Transmit Check Character	162
AIM 128.....	163
Restore Factory Defaults	163
Enable/Disable AIM 128.....	163
Set Length Range for AIM 128.....	164
ISBT 128	165
Restore Factory Defaults	165
Enable/Disable ISBT 128	165
Code 49	166
Restore Factory Defaults	166
Enable/Disable AIM 49.....	166
Set Length Range for Code 49	167
Code 16K	168
Restore Factory Defaults	168
Enable/Disable AIM 49.....	168
Set Length Range for Code 16K	169
PDF417.....	170
Restore Factory Defaults	170
Enable/Disable PDF417	170
Set Length Range for PDF417.....	171
PDF417 Twin Code.....	172
PDF417 Inverse	173
Character Encoding	173
PDF417 ECI Output	174
Micro PDF417	175
Restore Factory Defaults	175
Enable/Disable Micro PDF417	175
Set Length Range for Micro PDF417	176
QR Code	177
Restore Factory Defaults	177
Enable/Disable QR Code	177
Set Length Range for QR Code	178
QR Twin Code	179
QR Inverse.....	180

Character Encoding	180
QR ECI Output.....	181
Website QR Code	181
Micro QR Code	182
Restore Factory Defaults	182
Enable/Disable Micro QR.....	182
Set Length Range for Micro QR.....	183
Aztec	184
Restore Factory Defaults	184
Enable/Disable Aztec Code	184
Set Length Range for Aztec Code	185
Read Multi-barcodes on an Image	186
Set the Number of Barcodes.....	187
Aztec Inverse	188
Character Encoding	189
Aztec ECI Output	189
Data Matrix.....	190
Restore Factory Defaults	190
Enable/Disable Data Matrix.....	190
Set Length Range for Data Matrix.....	191
Data Matrix Twin Code.....	192
Rectangular Barcode	193
Data Matrix Inverse.....	193
Character Encoding	194
Data Matrix ECI Output.....	194
Maxicode.....	195
Restore Factory Defaults	195
Enable/Disable Maxicode.....	195
Set Length Range for Maxicode.....	196
Chinese Sensible Code.....	197
Restore Factory Defaults	197
Enable/Disable Chinese Sensible Code.....	197
Set Length Range for Chinese Sensible Code.....	198
Chinese Sensible Twin Code	199
Chinese Sensible Code Inverse.....	200
ECI Output	200
GM Code.....	201

Restore Factory Defaults	201
Enable/Disable GM	201
Set Length Range for GM	202
Code One	203
Restore Factory Defaults	203
Enable/Disable Code One	203
Set Length Range for Code One	204
DotCode	205
Restore Factory Defaults	205
Enable/Disable DotCode	205
USPS Postnet	206
Restore Factory Defaults	206
Enable/Disable USPS Postnet	206
Transmit Check Character	206
USPS Intelligent Mail	207
Restore Factory Defaults	207
Enable/Disable USPS Intelligent Mail	207
Royal Mail	208
Restore Factory Defaults	208
Enable/Disable Royal Mail	208
USPS Planet	209
Restore Factory Defaults	209
Enable/Disable USPS Planet	209
Transmit Check Character	209
KIX Post	210
Restore Factory Defaults	210
Enable/Disable KIX Post	210
Australian Postal	211
Restore Factory Defaults	211
Enable/Disable Australian Postal	211
Japan Post	212
Restore Factory Defaults	212
Enable/Disable Specific Japan Post	212
Passport OCR	213
Restore Factory Defaults	213
Enable/Disable Passport OCR	213
Chinese ID Card OCR	214

Restore Factory Defaults	214
Enable/Disable Chinese ID Card OCR.....	214
China Travel Permit OCR.....	215
Restore Factory Defaults	215
Enable/Disable Chinese Travel Permit OCR.....	215
Chapter 6 Prefix&Suffix	216
Introduction	216
Global Settings.....	217
Enable/Disable All Prefixes/Suffixes	217
Prefix Sequence.....	217
Custom Prefix.....	218
Enable/Disable Custom Prefix	218
Set Custom Prefix	218
AIM ID Prefix	219
Code ID Prefix.....	220
Restore All Default Code IDs	220
Modify Code ID	220
Custom Suffix.....	252
Enable/Disable Custom Suffix.....	252
Set Custom Suffix	252
Data Packing.....	253
Introduction	253
Data Packing Options	253
Terminating Character Suffix.....	255
Enable/Disable Terminating Character Suffix.....	255
Set Terminating Character Suffix	255
Chapter 7 Batch Programming.....	257
Introduction	257
Create a Batch Command.....	258
Create a Batch Barcode.....	258
Use Batch Barcode	259
Appendix	260
Digit Barcodes.....	260
Save/Cancel Barcodes.....	263
Factory Defaults Table	264
AIM ID Table	273

Code ID Table	275
Symbology ID Number	276
ASCII Table.....	278
Unicode Key Maps	282

Preface

Introduction

This manual provides detailed instructions for setting up and using the NLS-HR3000-BT wireless 2D barcode scanner (hereinafter referred to as “**the HR3000-BT**” or “**the scanner**”).

Chapter Description

<i>Chapter 1 Getting Started</i>	: Gives a general description of HR3000-BT scanner
<i>Chapter 2 EasySet</i>	: Introduces a useful tool you can use to set up HR3000-BT scanner.
<i>Chapter 3 System Settings</i>	: Introduces three configuration methods and describes how to configure general parameters of HR3000-BT scanner.
<i>Chapter 4 Wireless Communications</i>	: Describes how to configure the parameters necessary for wireless communication between the scanner, cradle and host device.
<i>Chapter 5 Symbologies</i>	: Lists all compatible symbologies and describes how to configure the relevant parameters.
<i>Chapter 6 Prefix & Suffix</i>	: Describes how to use prefix and suffix to customize scanned data.
<i>Chapter 7 Batch Programming</i>	: Explains how to integrate a complex programming task into a single barcode.
<i>Appendix</i>	: Provides factory defaults table and a bunch of frequently used programming barcodes.

Explanation of Icons



This icon indicates something relevant to this manual.



This icon indicates this information requires extra attention from the reader.



This icon indicates handy tips that can help you use or configure the scanner with ease.



This icon indicates practical examples that can help you to acquaint yourself with opera

Chapter 1 Getting Started

Introduction

The HR3000-BT wireless 2D barcode scanner reads a 1D or 2D barcode by capturing its image. Adopting the advanced **UING** technology independently developed by Newland Auto-ID Tech, it provides five scan modes, including Level mode, Sense mode, Continuous mode, Pulse mode and Batch mode, tailored to different scanning needs.

An illustrated introduction to the HR3000-BT is included in this chapter. If you have an HR3000-BT scanner at hand, make good use of it to develop a better understanding of this manual. This chapter is written for normal users, maintenance staff and software developers.

Features of the HR3000-BT

- Easily reads all mainstream 1D and 2D barcodes on the market.
- Integrated with a high-performance processor and scan engine, offering fast decoding and high-precision reading capabilities.
- Stable wireless transmission technology with strong anti-interference ability.
- Easy to configure functions and update firmware.

Unpacking

Open the package and take out HR3000-BT scanner and its accessories. Check to make sure everything on the packing list is present and intact. If any contents are damaged or missing, please keep the original package and contact your dealer immediately for after-sales service.

The Scanner

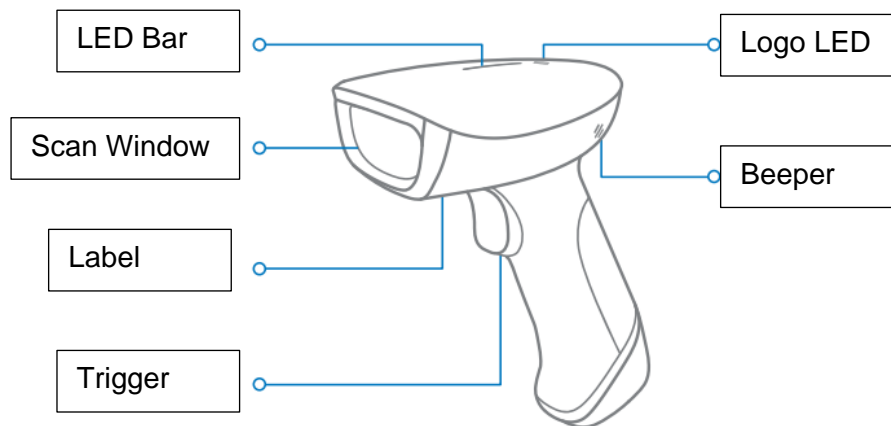

LED Notification:

Logo LED (Battery indicator)

Red LED flashes - Low battery alert.

Red LED on – Charging

White LED on – Battery 100%

LED Bar

White LED On - Bluetooth Connection.

White LED Flash – Bluetooth Disconnection.

Green LED flashes once - Good Read.

Red LED on – Host Communication Indicator.

Dimensions of the Scanner (unit: mm)

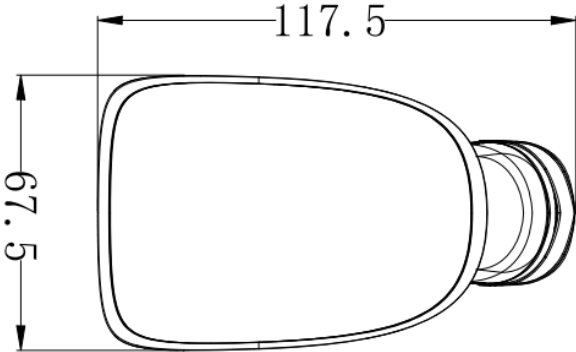
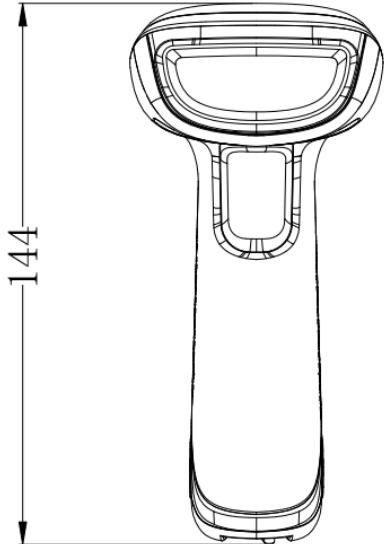
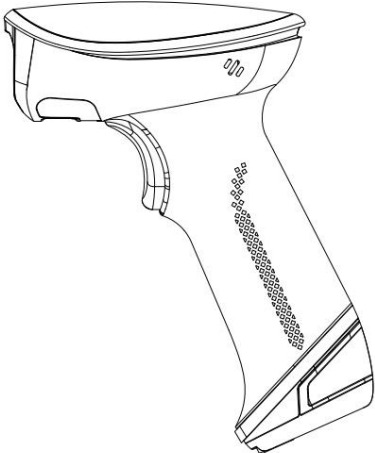

HCD20 Cradle

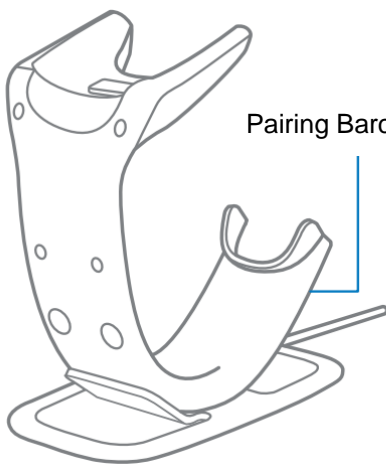
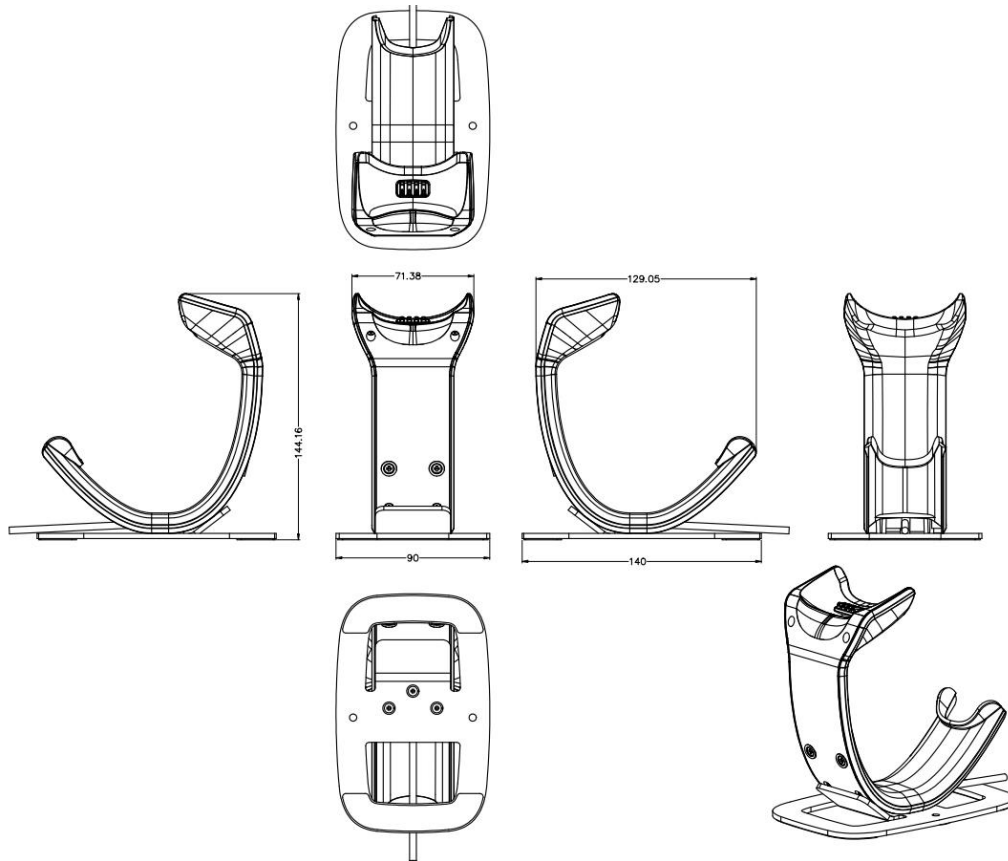

Pairing Barcode

Scanner is paired with the cradle by default.

Connect scanner with other cradles:

- 1, Power off the scanner or clear the pairing information on the scanner
- 2, Scan the pairing barcode on the bottom of cradle

Connecting the Cradle to a Host

The cradle can be connected to a host in actual application, such as PC, POS or any intelligent terminal with USB port, using a communication cable (USB or RS-232 cable).

USB

USB port on the Host

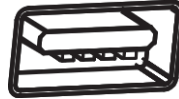

Note: Please check the port on the host and purchase the cable accordingly.

Using USB Cable

Connect the cradle to a Host using a USB cable with RJ45 and USB connectors:

1. Plug the RJ45 connector of the cable into the data port on the cradle.
2. Plug the USB connector of the cable into the USB port on the Host.
3. Plug the supplied power adapter into the power jack on the cradle.

Pairing the Scanner to a Cradle

Before configuring or using the scanner, you must pair it to a cradle first.

You need to perform the pairing operation manually: After the scanner and cradle are turned on, insert the scanner in the cradle and then scan the Pairing Barcode on the bottom of the cradle. The scanner beeps on a successful pairing.

To unpair them, you may pair the scanner to another cradle, or scan the **Clear Pairing Info on Cradle** or **Clear Pairing Info on Scanner** barcode in Chapter 4.

Power On, Power Off, Reboot

Power on the scanner

Hold down the trigger on the scanner until it beeps.

Note: When using the scanner for the first time or after scanning the **Battery Off** barcode in Chapter 3, you MUST insert the scanner in a powered cradle to exit battery protection mode before turning it on.

Power off the scanner

Method 1: When in the Level scan mode, the scanner will automatically power off after a specific period of inactivity (default: 5 minutes, programmable). To change the period, see the “Auto Power-Off Timeout” section in Chapter 3.

Method 2: Scan the **Power Off Scanner** barcode in Chapter 3.

Reboot the scanner

If the scanner stops responding to input or runs abnormally, press and hold the Reset button on the bottom of the scanner with a straightened paperclip to reboot it.

Chapter 2 Easyset

EasySet, developed by Fujian Newland Auto-ID Tech. Co., Ltd., is a configuration tool for Newland's 1D/2D handheld barcode scanner, fixed mount barcode scanners and OEM scan engines. Its main features include:

- ✧ View device & configuration information of online device
- ✧ Configure device
- ✧ Update firmware of online device
- ✧ Load/modify existing XML configuration file; save current settings to an XML file
- ✧ Create/print/save programming barcodes to a PDF or Word file
- ✧ View/edit/save image stored on online device in the original image/BMP/JPG/TIFF format
- ✧ Send serial commands to online device and receive device response
- ✧ Supported languages: Chinese and English.

EasySet supports 32-bit/64-bit Microsoft WinXP/Win7/Win 8/Win 8.1/Win 10 operating systems.

EasySet can communicate with device via one of the following interface: RS-232, USB COM Port Emulation (UFCOM driver required), USB CDC (UFCOM driver required), USB DataPipe (UFCOM driver required), USB HID-POS.

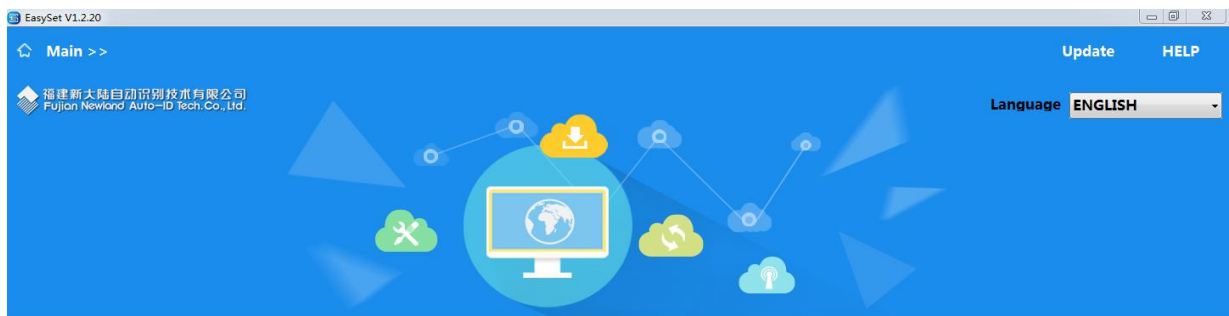



#SETUPE1
Enter Setup

Chapter 3 System Setting

Introduction

There are three ways to configure the HR3000-BT: Barcode programming, command programming and Easyset programming.

Barcode Programming

The HR3000-BT can be configured by scanning programming barcodes. All user programmable features/options are described along with their programming barcodes/commands in the following sections.

This programming method is most straightforward. However, it requires manually scanning barcodes. As a result, errors are more likely to occur.

Command Programming

The HR3000-BT can also be configured by serial commands (HEX) sent from the host device.

Users can design an application program to send those command strings to the scanners to perform device configuration.

EasySet Programming

Besides the two methods mentioned above, you can conveniently perform scanner configuration through EasySet too. EasySet is a Windows-based configuration tool particularly designed for Newland products, enabling users to gain access to decoded data and captured images and to configure scanners. For more information about this tool, refer to the *EasySet User Guide*.



Before programming the scanner, you need to pair it to a cradle first. When programming the scanner with serial commands or EasySet, you need to insert it in the paired cradle.

Except some temporary setting will be disappeared after reboot and power off, other setting information will be stored in the scanner.



#SETUPE1
Enter Setup

Programming Barcode/ Programming Command/Function



The figure above is an example that shows you the programming barcode and command for the Enter Setup function:

1. The **No Case Conversion** barcode.
2. The **No Case Conversion** command.
3. The description of feature/option.
4. ** indicates factory default settings.

Note: "@" included in the programming command indicates permanent setting which means the setting will not be lost by removing power from the scanner or turning off or rebooting it; whereas "#" included in the programming command indicates temporary setting which means the setting will be lost by removing power from the scanner or turning off or rebooting it.



#SETUPE0
** Exit Setup



#SETUPE1
Enter Setup

Use of Programming Command

Besides the barcode programming method, the scanner can also be configured by serial commands (HEX) sent from the host device. **All commands must be entered in uppercase letters.**

Use of Programming Barcodes

Scanning the **Enter Setup** barcode can enable the scanner to enter the setup mode. Then you can scan a number of programming barcodes to configure your scanner. To exit the setup mode, scan the **Exit Setup** barcode or a non-programming barcode, or reboot the scanner.



@SETUPE0
**** Exit Setup**



@SETUPE1
Enter Setup

Programming barcode data (i.e. the characters under programming barcode) can be transmitted to the host device. You may scan the appropriate barcode below to enable or disable the transmission of programming barcode data to the host device.



#SETUPT0
**** Do Not Transmit Programming Barcode Data**



#SETUPT1
Transmit Programming Barcode Data



#SETUPE0
**** Exit Setup**



#SETUPE1
Enter Setup

Illumination



@ILLSCN1
** On



@ILLSCN0
Off

Aiming

When scanning/capturing image, the scanner projects an aiming pattern which allows positioning the target barcode within its field of view and thus makes decoding easier.

Normal: The scanner projects an aiming pattern only during barcode scanning/capture.

Always On: Aiming pattern is constantly on after the scanner is powered on.

Off: Aiming pattern is off all the time.



@AMLENA1
** Normal



@AMLENA0
Off



@AMLENA2
Always On



#SETUPE0
** Exit Setup



#SETUPE1
Enter Setup

Good Read LED

The green LED can be programmed to be On or Off to indicate good read.



@GRLENA1
** On



@GRLENA0
Off

Good Read LED Duration

This parameter sets the amount of time the Good Read LED remains on following a good read.



@GRLDUR20
** Short (20ms)



@GRLDUR120
Medium (120ms)



@GRLDUR220
Long (220ms)



@GRLDUR320
Prolonged (320ms)



@GRLDUR
Custom (1 - 2,500ms)



#SETUPE0
** Exit Setup



#SETUPE1
Enter Setup

Example

Set the Good Read LED duration to 800ms:

1. Scan the **Enter Setup** barcode.
2. Scan the **Custom** barcode.
3. Scan the numeric barcodes "8", "0" and "0" from the "Digit Barcodes" section in Appendix.
4. Scan the **Save** barcode from the "Save/Cancel Barcodes" section in Appendix.
5. Scan the **Exit Setup** barcode.

Power On Beep

The scanner can be programmed to beep when it is powered on. Scan the **Off** barcode if you do not want a power on beep.



@PWBENA1
** On



@PWBENA0
Off

Good Read Beep

Scanning the **Off** barcode can turn off the beep that indicates successful decode; scanning the **On** barcode can turn it back on.



@GRBENA1
** On



@GRBENA0
Off



#SETUPE0
** Exit Setup



#SETUPE1
Enter Setup

Good Read Beep Duration

This parameter sets the length of the beep the scanner emits on a good read. It is programmable in 1ms increments from 20ms to 300ms.



@GRBDUR40
Short (40ms)



@GRBDUR80
**** Medium (80ms)**



@GRBDUR120
Long (120ms)



@GRBDUR
Custom (20 – 300ms)

E
example

Set the Good Read Beep duration to 200ms:

1. Scan the **Enter Setup** barcode.
2. Scan the **Custom** barcode.
3. Scan the numeric barcodes “2”, “0” and “0” from the “Digit Barcodes” section in Appendix.
4. Scan the **Save** barcode from the “Save/Cancel Barcodes” section in Appendix.
5. Scan the **Exit Setup** barcode.



#SETUPE0
**** Exit Setup**



#SETUPE1
Enter Setup

Good Read Beep Frequency

This parameter is programmable in 1Hz increments from 20Hz to 20,000Hz.



@GRBFRQ800
Extra Low (800Hz)



@GRBFRQ1600
Low (1600Hz)



@GRBFRQ2730
**** Medium (2730Hz)**



@GRBFRQ4200
High (4200Hz)



@GRBFRQ
Custom (20 - 20,000Hz)

E
sample

Set the Good Read Beep frequency to 2,000Hz:

1. Scan the **Enter Setup** barcode.
2. Scan the **Custom** barcode.
3. Scan the numeric barcodes “2”, “0”, “0” and “0” from the “Digit Barcodes” section in Appendix.
4. Scan the **Save** barcode from the “Save/Cancel Barcodes” section in Appendix.
5. Scan the **Exit Setup** barcode.



#SETUPE0
**** Exit Setup**



#SETUPE1
Enter Setup

Good Read Beep Volume



@GRBVOL0
**** Loud(20)**



@GRBVOL2
Low(5)



@GRBVOL1
Medium(12)



@GRBVLL
Custom (1-20)

E
sample

Set the Good Read Beep Volume to 20

1. Scan the **Enter Setup** barcode.
2. Scan the **Custom** barcode.
3. Scan the numeric barcodes “2”, “0” from the “Digit Barcodes” section in Appendix.
4. Scan the **Save** barcode from the “Save/Cancel Barcodes” section in Appendix.
5. Scan the **Exit Setup** barcode.



#SETUPE0
**** Exit Setup**



#SETUPE1
Enter Setup

Remind Beep Volume

This parameter is available for reminder beep volume of the following operations: power on (for all products), power off, batch transmission, pairing the scanner to a cradle, searching paired scanner, the scanner connects on the cradle, the scanner disconnects the cradle, bluetooth connection and transmission.



@SUCVLL20
** Loud



@SUCVLL12
Medium



@SUCVLL5
Low



@SUCVLL0
Mute



@SUCVLL
Custom (0-20)

Example

Set the above operations' beep volume to 10:

1. Scan the **Enter Setup** barcode.
2. Scan the **Beep Volume** barcode.
3. Scan the numeric barcodes "1" and "0" from the "Digit Barcodes" section in Appendix.
4. Scan the **Save** barcode from the "Save/Cancel Barcodes" section in Appendix.
5. Scan the **Exit Setup** barcode.



#SETUPE0
** Exit Setup



#SETUPE1
Enter Setup

Scan Mode

Level Mode: A trigger pull activates a decode session. The decode session continues until a barcode is decoded or you release the trigger.

Sense Mode: The scanner activates a decode session every time it detects a barcode presented to it. The decode session continues until a barcode is decoded or the decode session timeout expires. **Reread Timeout** can avoid undesired rereading of same barcode in a given period of time. **Sensitivity** can change the Sense Mode's sensibility to changes in images captured. **Image Stabilization Timeout** gives the scanner time to adapt to ambient environment after it decodes a barcode and "looks" for another.

Continuous Mode: The scanner automatically starts one decode session after another. To suspend/resume barcode reading, simply press the trigger. **Reread Timeout** can avoid undesired rereading of same barcode in a given period of time.

Pulse Mode: When the trigger is pulled and released, scanning is activated until a barcode is decoded or the decode session timeout expires (The decode session timeout begins when the trigger is released).

Batch Mode: A trigger pull activates a round of multiple decode sessions. This round of multiple scans continues until you release the trigger. Rereading the same barcode is not allowed in the same round.



@SCNMOD0
** Level Mode



@SCNMOD2
Sense Mode



@SCNMOD3
Continuous Mode



@SCNMOD7
Batch Mode



@SCNMOD4
Pulse Mode



#SETUPE0
** Exit Setup



#SETUPE1
Enter Setup

Decode Session Timeout

This parameter sets the maximum time decode session continues during a scan attempt. It is programmable in 1 ms increments from 100ms to 3,600,000ms. When it is set to 0, the timeout is infinite. The default setting is 3,000ms.



@ORTSET
Decode Session Timeout

E *Example*

Set the decode session timeout to 1,500ms:

1. Scan the **Enter Setup** barcode.
2. Scan the **Decode Session Timeout** barcode.
3. Scan the numeric barcodes “1”, “5”, “0” and “0” from the “Digit Barcodes” section in Appendix.
4. Scan the **Save** barcode from the “Save/Cancel Barcodes” section in Appendix.
5. Scan the **Exit Setup** barcode.



#SETUPE0
**** Exit Setup**



#SETUPE1
Enter Setup

Image Stabilization Timeout (Sense Mode)

This parameter defines the amount of time the scanner will spend adapting to ambient environment after it decodes a barcode and “looks” for another. It is programmable in 1ms increments from 0ms to 3,000ms. The default setting is 200ms.



Image Stabilization Timeout

E
example

Set the image stabilization timeout to 800ms:

2. Scan the **Enter Setup** barcode.
3. Scan the **Image Stabilization Timeout** barcode.
4. Scan the numeric barcodes “8”, “0” and “0” from the “Digit Barcodes” section in Appendix.
5. Scan the **Save** barcode from the “Save/Cancel Barcodes” section in Appendix.
6. Scan the **Exit Setup** barcode.



#SETUPE0
**** Exit Setup**



#SETUPE1
Enter Setup

Reread Timeout

Reread Timeout can avoid undesired rereading of same barcode in a given period of time. This feature is only applicable to the Sense and Continuous modes.

Enable Reread Timeout: Do not allow the scanner to reread same barcode before the reread timeout expires.

Disable Reread Timeout: Allow the scanner to reread same barcode.



@RRDENA1
Enable Reread Timeout



@RRDENA0
**** Disable Reread Timeout**

The following parameter sets the time interval between two successive reads on same barcode. It is programmable in 1ms increments from 0ms to 3,600,000ms. When it is set to a value greater than 3,000, the timeout for rereading same programming barcode is limited to 3,000ms. The default setting is 1,500ms.



@RRDDUR
Set Reread Timeout

E
example

Set the reread timeout to 1,000ms:

1. Scan the **Enter Setup** barcode.
2. Scan the **Set Reread Timeout** barcode.
3. Scan the numeric barcodes “1”, “0”, “0” and “0” from the “Digit Barcodes” section in Appendix.
4. Scan the **Save** barcode from the “Save/Cancel Barcodes” section in Appendix.
5. Scan the **Exit Setup** barcode.



#SETUPE0
**** Exit Setup**



#SETUPE1

Enter Setup

You may wish to restart the reread timeout when the scanner encounters the same barcode that was decoded in the last scan session before the reread timeout expires. To enable this feature, scan the **Reread Timeout Reset On** barcode. This feature is only effective when **Reread Timeout** is enabled.



@RRDREN1

Reread Timeout Reset On



@RRDREN0

**** Reread Timeout Reset Off**

Image Decoding Timeout

Image Decoding Timeout specifies the maximum time the scanner will spend decoding an image. This parameter is programmable in 1ms increments from 1ms to 3,000ms. The default timeout is 500ms.



@DETSET

Image Decoding Timeout

E
sample

Set the image decoding timeout to 1,000ms:

1. Scan the **Enter Setup** barcode.
2. Scan the **Image Decoding Timeout** barcode.
3. Scan the numeric barcodes “1”, “0”, “0” and “0” from the “Digit Barcodes” section in Appendix.
4. Scan the **Save** barcode from the “Save/Cancel Barcodes” section in Appendix.
5. Scan the **Exit Setup** barcode.



#SETUPE0

**** Exit Setup**



#SETUPE1
Enter Setup

Image Decoding Preference

When the scanner is set as **Barcodes on Screen**, decoding rate reduces obviously.



@DETPFN1
Screen Barcodes



@DETPFN0
**** Paper Barcodes**



#SETUPE0
**** Exit Setup**



#SETUPE1

Enter Setup

Sensitivity (Sense Mode)

This specifies the degree of acuteness of the scanner's response to changes in images captured. There are 20 levels to choose from. The smaller the value, the higher the sensitivity and the lower requirement in image change to trigger the scanner. You can select an appropriate degree of sensitivity that fits your application environment. This feature is only applicable to the Sense mode.



@SENLVL14

Low Sensitivity



@SENLVL11

Medium Sensitivity



@SENLVL8

High Sensitivity



@SENLVL5

****Enhanced Sensitivity**



@SENLVL

E
sample

Set the sensitivity to Level 10:

1. Scan the **Enter Setup** barcode.
2. Scan the **Custom Sensitivity** barcode.
3. Scan the numeric barcodes "1" and "0" from the "Digit Barcodes" section in Appendix.
4. Scan the **Save** barcode from the "Save/Cancel Barcodes" section in Appendix.
5. Scan the **Exit Setup** barcode.



#SETUPE0

**** Exit Setup**



#SETUPE1
Enter Setup

Scanning Preference

Normal Mode: Select this mode when reading barcodes on paper.

Screen Mode: Select this mode when reading barcodes on the screen.



@EXPLVL0
**** Normal Mode**



@EXPLVL2
Screen Mode



#SETUPE0
**** Exit Setup**



#SETUPE1
Enter Setup

BEL Character Beep

The beep when the scanner receives BEL character(0x07)



@BELENA1
On



@BELENA0
**** Off**



#SETUPE0
**** Exit Setup**



#SETUPE1
Enter Setup

Surround GS1 Application Identifiers (AIs) with Parentheses

When **Surround GS1 AIs with Parentheses** is selected, each application identifier (AI) contained in scanned data will be enclosed in parentheses in the output message.



@GS1AIP0

**** Do Not Surround GS1 AIs with Parentheses**



@GS1AIP1

Surround GS1 AIs with Parentheses

E
xample

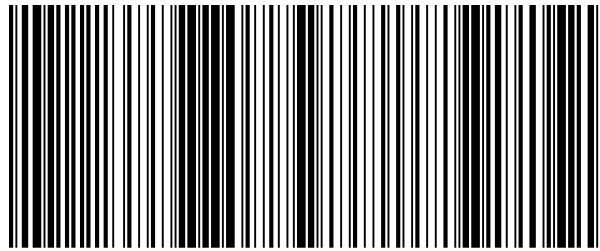

(01) 0 0614141 99999 6 (10) 10ABCEDF123456

If **Surround GS1 AIs with Parentheses** is selected, the barcode above is output as
(01)00614141999996(10)10ABCEDF123456.

If **Do Not Surround GS1 AIs with Parentheses** is selected, the barcode above is output as
01006141419999961010ABCEDF123456.



#SETUPE0
**** Exit Setup**



#SETUPE1
Enter Setup

Output GS1 Application Identifiers (AIs)



@GS10AI0
Do Not Output GS1 AIs



@GS10AI1
** Output GS1 AIs

E
xample

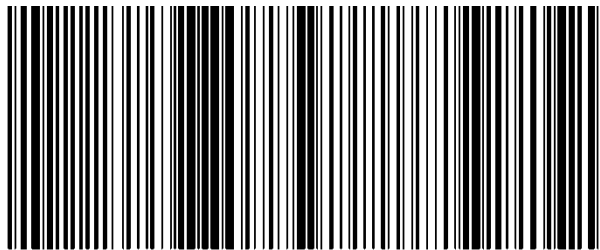

(01) 0 0614141 99999 6 (10) 10ABCEDF123456

If **Output GS1 AIs** is selected, the barcode above is output as

01006141419999961010ABCEDF123456

If **Do Not Output GS1 AIs** is selected, the barcode above is output as 0061414199999610ABCEDF123456



#SETUPE0
** Exit Setup



#SETUPE1
Enter Setup

GS1 Composite



@GS1OAC0
Do Not Output GS1 AIs



@GS1OAC1
** Output GS1 AIs

GS1 Databar(RSS)

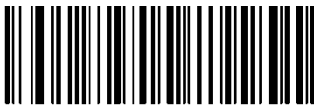

@GS1OAR0
Do Not Output GS1 AIs



@GS1OAR1
** Output GS1 AIs

GS1 QR



@GS1OAQ0
Do Not Output GS1 AIs



@GS1OAQ1
** Output GS1 AIs



#SETUPE0
** Exit Setup



#SETUPE1
Enter Setup

GS1 Data Matrix



@GS1OAD0
Do Not Output GS1 Als



@GS1OAD1
**** Output GS1 Als**



#SETUPE0
**** Exit Setup**



#SETUPE1
Enter Setup

Transmit GS1 Check Character



@GS1OCK0

Do Not Transmit GS1 Check Character



@GS1OCK1

** Transmit GS1 Check Character

E
xample

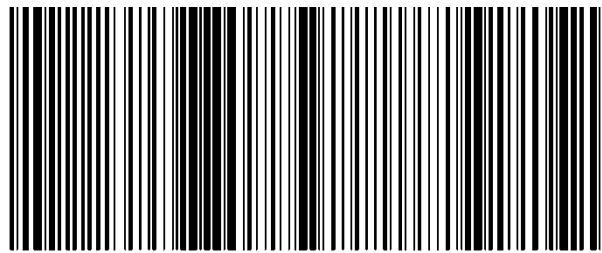

(01) 0 0614141 99999 6 (10) 10ABCEDF123456

If **Transmit GS1 Check Character** is selected, the barcode above is output as

01006141419999961010ABCEDF123456

If **Do Not Transmit GS1 Check Character** is selected, the barcode above is output as

0100614141999991010ABCEDF123456



#SETUPE0
** Exit Setup



#SETUPE1
Enter Setup

Read Barcode On/Off

Sending the Read Barcode Off command `~<SOH>0000#SCNENA0;<ETX>` to the scanner can disable it from reading barcode, and the scanner is unable to scan barcode unless you send the Read Barcode On command `~<SOH>0000#SCNENA1;<ETX>` to it or power cycle it. By default, Read Barcode is On.

Smart Stand Mode

After this feature is turned on, the scanner will switch from its current scan mode to the Sense mode when it is inserted in the stand, and it will operate in its previous scan mode when it is removed from the stand.



@SMTENA0
Off



@SMTENA1
** On



#SETUPE0
** Exit Setup



#SETUPE1
Enter Setup

Decode Area

Whole Area Decoding: The scanner attempts to decode barcode(s) within its field of view, from the center to the periphery, and transmits the barcode that has been first decoded.

Specific Area Decoding: The scanner attempts to read barcode(s) within a specified decoding area and transmits the barcode that has been first decoded. This option allows the scanner to narrow its field of view to make sure it reads only those barcodes intended by the user. For instance, if multiple barcodes are placed closely together, specific area decoding in conjunction with appropriate pre-defined decoding area will insure that only the desired barcode is read.

Acuscan: The scanner only decodes the barcode aimed squarely by the aiming pattern. For those using a crosshair aiming pattern, only the barcode aimed by the center of crosshair will be decoded.



@CADENA0

**** Whole Area Decoding**



@CADENA1

Specific Area Decoding



@CADENA2

Acuscan

If **Specific Area Decoding** is enabled, the scanner only reads barcodes that intersect the predefined decoding area.

The default decoding area is an area of 40% top, 60% bottom, 40% left and 60% right of the scanner's field of view

You can define the decoding area using the **Top of Decoding Area**, **Bottom of Decoding Area**, **Left of Decoding Area** and **Right of Decoding Area** barcodes as well as numeric barcode(s) that represent(s) a desired percentage (0-100). The value of Bottom must be greater than that of Top; the value of Right must be greater than that of Left.



@CADTOP

Top of Decoding Area



#SETUPE0
**** Exit Setup**



#SETUPE1
Enter Setup



@CABOT
Bottom of Decoding Area



@CADLEF
Left of Decoding Area



@CADRIG
Right of Decoding Area



#SETUPE0
**** Exit Setup**



#SETUPE1
Enter Setup

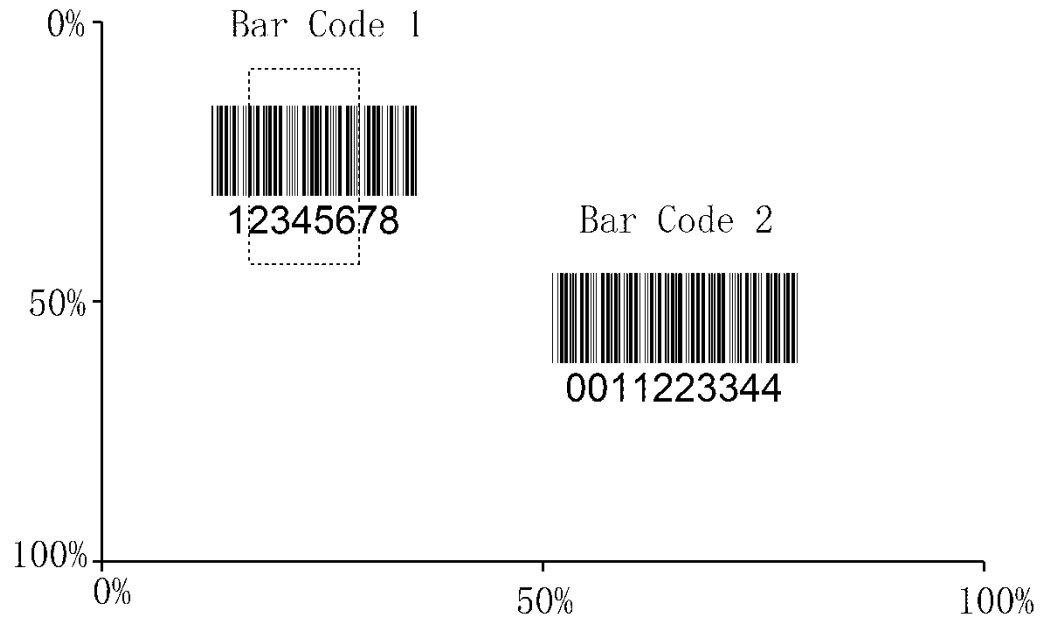

E *sample*

Program the scanner to only read Barcode 1 in the figure above by setting the decoding area to 10% top, 45% bottom, 15% left and 30% right:

1. Scan the **Enter Setup** barcode.
2. Scan the **Top of Decoding Area** barcode.
3. Scan the numeric barcode "0" from the "Digit Barcodes" section in Appendix.
4. Scan the **Save** barcode from the "Save/Cancel Barcodes" section in Appendix.
5. Scan the **Bottom of Decoding Area** barcode.
6. Scan the numeric barcodes "4" and "5" from the "Digit Barcodes" section in Appendix.
7. Scan the **Save** barcode from the "Save/Cancel Barcodes" section in Appendix.
8. Scan the **Top of Decoding Area** barcode.
9. Scan the numeric barcodes "1" and "0" from the "Digit Barcodes" section in Appendix.
10. Scan the **Save** barcode from the "Save/Cancel Barcodes" section in Appendix.
11. Scan the **Left of Decoding Area** barcode.
12. Scan the numeric barcode "0" from the "Digit Barcodes" section in Appendix.
13. Scan the **Save** barcode from the "Save/Cancel Barcodes" section in Appendix.
14. Scan the **Right of Decoding Area** barcode.
15. Scan the numeric barcodes "3" and "0" from the "Digit Barcodes" section in Appendix.
16. Scan the **Save** barcode from the "Save/Cancel Barcodes" section in Appendix.



#SETUPE0
** Exit Setup



#SETUPE1

Enter Setup

17. Scan the **Left of Decoding Area** barcode.
18. Scan the numeric barcodes “1” and “5” from the “Digit Barcodes” section in Appendix.
19. Scan the **Save** barcode from the “Save/Cancel Barcodes” section in Appendix.
20. Scan the **Exit Setup** barcode.



#SETUPE0

**** Exit Setup**



#SETUPE1
Enter Setup

Image Flipping



@MIRROR0

** Do Not Flip



@MIRROR1

Flip Horizontally



@MIRROR2

Flip Vertically



@MIRROR3

Flip Horizontally & Vertically

Example of image not flipped



Example of image flipped horizontally



Example of image flipped vertically



Example of image flipped horizontally & vertically



#SETUPE0
** Exit Setup



#SETUPE1
Enter Setup

Bad Read Message

You may scan the appropriate barcode below to select whether or not to send a bad read message (user-programmable) when a good read does not occur before trigger release, or the decode session timeout expires.



@NGRENA0
**** Bad Read Message OFF**



@NGRENA1
Bad Read Message ON

Set Bad Read Message

A bad read message can contain up to 7 characters (HEX values from 0x00 to 0xFF). To set a bad read message, scan the **Set Bad Read Message** barcode, the numeric barcodes representing the hexadecimal values of desired character(s) and the **Save** barcode. The default setting is “NG”.



@NGRSET
Set Bad Read Message

E
xample

Set the bad read message to “F” (HEX: 0x46):

1. Scan the **Enter Setup** barcode.
2. Scan the **Set Bad Read Message** barcode.
3. Scan the numeric barcodes “4” and “6” from the “Digit Barcodes” section in Appendix.
4. Scan the **Save** barcode from the “Save/Cancel Barcodes” section in Appendix.
5. Scan the **Exit Setup** barcode.



#SETUPE0
**** Exit Setup**



#SETUPE1
Enter Setup

Power Off



@PWROFF
Power Off Scanner

Default Settings

Factory Defaults

Scanning the **Reset Scanner** barcode can restore the scanner to the factory defaults. You may need to reset your scanner when:

1. Scanner is not properly configured so that the scanner fails to decode barcodes or to communicate with the cradle.
2. you forget previous configuration and want to avoid its impact.
3. functions that are rarely used have been enabled for the time being.



@FACDEF
Reset Scanner

Custom Defaults

Scanning the **Restore All Custom Defaults** barcode can reset all parameters on the scanner to the custom defaults. Scanning the **Save as Custom Defaults** barcode can set the current settings as custom defaults.

Custom defaults are stored in the non-volatile memory.



@CUSSAV
Save as Custom Defaults



@CUSDEF
Restore All Custom Defaults



Restoring the scanner to the factory defaults will not remove the custom defaults from the scanner.



#SETUPE0
** Exit Setup



#SETUPE1
Enter Setup

Query Scanner Information

After scanning the barcode below, the scanner information (including product name, firmware version, decoder version, hardware version, product serial number, OEM serial number and manufacturing date) will be sent to the host device.



@QRYSYS

Query Scanner Information

Query Product Name



@QRYPDN

Query Product Name

Query Firmware Version



@QRYFWW

Query Firmware Version

Query Decoder Version



@QRYDCV

Query Decoder Version



#SETUPE0
**** Exit Setup**



#SETUPE1
Enter Setup

Query Data Formatter Version



@QRYDFM
Query Data Formatter Version

Query Hardware Version



@QRYHWW
Query Hardware Version

Query Serial Number



@QRYPSN
Query Serial Number

Query OEM Serial Number



@QRYESN
Query OEM Serial Number



#SETUPE0
** Exit Setup



#SETUPE1
Enter Setup

Chapter 4 Wireless Communication

Bluetooth HID



@INTERF10
Bluetooth HID

Bluetooth BLE



@INTERF11
Bluetooth BLE

Bluetooth Dongle KBW

In this mode, Bluetooth dongle equals to a keyboard



@INTERF19
**Bluetooth Dongle KBW



If the host device allows keyboard input, then no extra software is needed for HID Keyboard input.



#SETUPE0
** Exit Setup



#SETUPE1
Enter Setup

USB Country Keyboard Types

Keyboard layouts vary from country to country. The default setting is U.S. keyboard.



@KBWCTY0
**** U.S. (English)**



@KBWCTY2
Brazil



@KBWCTY4
Czechoslovakia



@KBWCTY6
Finland (Swedish)



@KBWCTY1
Belgium



@KBWCTY3
Canada (French)



@KBWCTY5
Denmark



#SETUPE0
**** Exit Setup**



#SETUPE1

Enter Setup



@KBWCTY7

France



@KBWCTY8

Germany/ Australia



@KBWCTY9

Greece



@KBWCTY10

Hungary



@KBWCTY11

Israel (Hebrew)



@KBWCTY12

Italy



@KBWCTY13

Latin America/ South America



@KBWCTY14

Netherlands (Dutch)



#SETUPE0

**** Exit Setup**



#SETUPE1

Enter Setup



@KBWCTY15

Norway



@KBWCTY16

Poland



@KBWCTY17

Portugal



@KBWCTY18

Romania



@KBWCTY19

Russia



@KBWCTY21

Slovakia



@KBWCTY22

Spain

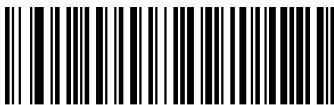

@KBWCTY23

Sweden



#SETUPE0

**** Exit Setup**



#SETUPE1

Enter Setup



@KBWCTY25

Turkey_F



@KBWCTY27

UK



@KBWCTY24

Switzerland (German)



@KBWCTY26

Turkey_Q



@KBWCTY28

Japan



#SETUPE0

**** Exit Setup**



#SETUPE1
Enter Setup

Beep on Unknown Character

Due to the differences in keyboard layouts, some characters contained in barcode data may be unavailable on the selected keyboard. As a result, the scanner fails to transmit the unknown characters.

Scan the appropriate barcode below to enable or disable the emission of beep when an unknown character is detected.



@KBWBUC0

**** Do Not Beep on Unknown Character**



@KBWBUC1

Beep on Unknown Character

E
sample

Supposing French keyboard (Country Code: 7) is selected and barcode data "ADF" is being dealt with, the keyboard will fail to locate the "D" (0xD0) character and the scanner will ignore the character and continue to process the next one.

Do Not Beep on Unknown Character: The scanner does not beep and the Host receives "AF".

Beep on Unknown Character: The scanner beeps and the Host still receives "AF".



If **Emulate ALT+Keypad ON** is selected, **Beep on Unknown Character** does not function.



#SETUPE0
**** Exit Setup**



#SETUPE1
Enter Setup

Emulate ALT+Keypad

When **Emulate ALT+Keypad** is turned on, any character is sent via the numeric keypad and overlook USB country keyboard type. This mode need to set **Code Page Option** and **Unicode Output**. **Code Page** determines the target language. **Unicode Output** determines the ASCII input to the host device.



@KBWALTO
** Emulate ALT+Keypad OFF



Emulate ALT+Keypad ON



ASCII characters between 0x00~0x1F will be input in way of Function Key Mapping Set.



Since sending a character involves multiple keystroke emulations, this method appears less efficient.



Supposing **Emulate ALT+Keypad** is ON, **Unicode Encoding** is Off, and **Code Page 1252 (West European Latin)** is selected, barcode data "ADF" (65/208/70) is sent as below:

"A" -- "ALT Make" + "065" + "ALT Break"

"D" -- "ALT Make" + "208" + "ALT Break"

"F" -- "ALT Make" + "070" + "ALT Break"



#SETUPE0
** Exit Setup



#SETUPE1
Enter Setup

Code Page

Code pages define the mapping of character codes to characters. If the data received does not display with the proper characters, it may be because the barcode being scanned was created using a code page that is different from the one the host program is expecting. If this is the case, select the code page with which the barcodes were created by scanning the appropriate barcode below. For PDF417, QR Code, Aztec and Data Matrix, besides setting the code page, you also need to set the character encoding in the "Character Encoding" section in Chapter 6. This feature is only effective when **Emulate ALT+Keypad** is turned on. The default setting is Code Page 1252(West European, Latin)



@KBWCPCG0

**** Code Page 1252 (West European Latin)**



@KBWCPCG1

Code Page 1251 (Cyrillic)



@KBWCPCG2

Code Page 1250 (Central and East European Latin)



@KBWCPCG3

Code Page 1253 (Greek)



@KBWCPCG4

Code Page 1254 (Turkish)



@KBWCPCG5

Code Page 1255 (Hebrew)



#SETUPE0
**** Exit Setup**



#SETUPE1

Enter Setup



@KBWCPG6

Code Page 1256 (Arabic)



@KBWCPG7

Code Page 1257 (Baltic)

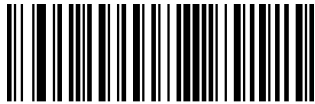

@KBWCPG8

Code Page 1258 (Vietnamese)



@KBWCPG9

Code Page 936 (Simplified Chinese, GB2312,GBK)



@KBWCPG11

Code Page 874(Thai)



#SETUPE0

**** Exit Setup**



#SETUPE1
Enter Setup

Unicode Encoding

Different host program may use different character encodings for handling incoming barcode data. For instance, Microsoft Office Word uses Unicode encoding and therefore you should turn **Unicode Encoding** on, whereas Microsoft Office Excel or Notepad uses Code Page encoding and therefore you should turn **Unicode Encoding** off. This feature is only effective when **Emulate ALT+Keypad** is turned on. The default setting is Off



@KBWCPU0
** Off



@KBWCPU1
On

Emulate Keypad with Leading Zero

You may turn this feature on to send character sequences sent over the numeric keypad as ISO characters which have a leading zero. For example, ASCII A transmits as "ALT MAKE" 0065 "ALT BREAK". This feature is only effective when **Emulate ALT+Keypad** is enabled.



@KBWALZ1
** On



@KBWALZ0
Off



#SETUPE0
** Exit Setup



#SETUPE1
Enter Setup

Function Key Mapping

When **Ctrl+ASCII Mode** is selected, function characters (0x00 - 0x1F) are sent as ASCII sequences. The default setting is Off.



@KBWFKM0
** Disable



@KBWFKM1
Ctrl+ASCII Mode



@KBWFKM2
Alt+Keypad Mode

Example

If **Ctrl+ASCII Mode** is selected and other parameters of USB HID Keyboard adopt factory defaults, barcode data “A<HT> (i.e. Horizontal Tab) F” (0x41/0x09/0x46) is sent as below:

“A” - Keystroke “A”.

<HT> - “Ctrl Make” + Keystroke “I” + “Ctrl Break”

“F” - Keystroke “F”

For some text editors, “Ctrl I” means italic convert. So the output may be “A*F*”.

If **Alt+Keypad Mode** is selected and other parameters of USB HID Keyboard adopt factory defaults, the data above is sent as below:

“A” - Keystroke “A”.

<HT> - “Alt Make” + Keystrokes “009” + “Alt Break”

“F” - Keystroke “F”



#SETUPE0
** Exit Setup



#SETUPE1

Enter Setup

ASCII Function Key Mapping Table

ASCII Function	ASCII Value (HEX)	Function Key Mapping Disabled	Ctrl+ASCII
NUL	00	Null	Ctrl+@
SOH	01	Keypad Enter	Ctrl+A
STX	02	Caps Lock	Ctrl+B
ETX	03	ALT	Ctrl+C
EOT	04	Null	Ctrl+D
ENQ	05	CTRL	Ctrl+E
ACK	06	Null	Ctrl+F
BEL	07	Enter	Ctrl+G
BS	08	Left Arrow	Ctrl+H
HT	09	Horizontal Tab	Ctrl+I
LF	0A	Down Arrow	Ctrl+J
VT	0B	Vertical Tab	Ctrl+K
FF	0C	Delete	Ctrl+L
CR	0D	Enter	Ctrl+M
SO	0E	Insert	Ctrl+N
SI	0F	Esc	Ctrl+O
DLE	10	F11	Ctrl+P
DC1	11	Home	Ctrl+Q
DC2	12	PrintScreen	Ctrl+R
DC3	13	Backspace	Ctrl+S
DC4	14	tab+shift	Ctrl+T
NAK	15	F12	Ctrl+U
SYN	16	F1	Ctrl+V
ETB	17	F2	Ctrl+W
CAN	18	F3	Ctrl+X
EM	19	F4	Ctrl+Y
SUB	1A	F5	Ctrl+Z
ESC	1B	F6	Ctrl+[
FS	1C	F7	Ctrl+\
GS	1D	F8	Ctrl+]
RS	1E	F9	Ctrl+6
US	1F	F10	Ctrl+-



#SETUPE0

** Exit Setup



#SETUPE1
Enter Setup

ASCII Function Key Mapping Table (Continued)

The last five characters (0x1B~0x1F) in the table above apply to US keyboard layout only. The following chart provides the equivalents of these five characters for other countries.

Country	Ctrl+AS CII					
United States	Ctrl +[Ctrl+\	Ctrl+]	Ctrl+6	Ctrl +-	
Belgium	Ctrl +[Ctrl+<	Ctrl+]	Ctrl+6	Ctrl +-	
Scandinavia	Ctrl +8	Ctrl+<	Ctrl+9	Ctrl+6	Ctrl +-	
France	Ctrl +^	Ctrl+8	Ctrl+\$	Ctrl+6	Ctrl +=	
Germany		Ctrl+Ã	Ctrl++	Ctrl+6	Ctrl +-	
Italy		Ctrl+\	Ctrl++	Ctrl+6	Ctrl +-	
Switzerland		Ctrl+<	Ctrl+..	Ctrl+6	Ctrl +-	
United Kingdom	Ctrl +[Ctrl+∅	Ctrl+]	Ctrl+6	Ctrl +-	
Denmark	Ctrl +8	Ctrl+\	Ctrl+9	Ctrl+6	Ctrl +-	
Norway	Ctrl +8	Ctrl+\	Ctrl+9	Ctrl+6	Ctrl +-	
Spain	Ctrl +[Ctrl+\	Ctrl+]	Ctrl+6	Ctrl +-	



#SETUPE0
** Exit Setup



#SETUPE1
Enter Setup

Inter-Keystroke Delay

This parameter specifies the delay between emulated keystrokes. Scanning below barcodes to delay longer when the host device needs slower data transmission. The default setting is No Delay.



@KBWDLY0
** No Delay



@KBWDLY40
Long Delay (40ms)



@KBWDLY20
Short Delay (20ms)

Caps Lock

The **Caps Lock ON** option can invert upper and lower case characters contained in barcode data. This inversion occurs regardless of the state of Caps Lock key on the host device's keyboard.



** Caps Lock OFF (Non-Japanese keyboard)



@KBWCAP1
Caps Lock ON (Non-Japanese keyboard)



Emulate ALT+Keypad ON/ Convert All to Upper Case/ Convert All to Lower Case prevails over Caps Lock ON.



When the **Caps Lock ON** feature is selected, barcode data "AbC" is transmitted as "aBc".



#SETUPE0
** Exit Setup



#SETUPE1
Enter Setup

Convert Case

Scan the appropriate barcode below to convert all barcode data to your desired case.



@KBWCAS0
**** No Case Conversion**



@KBWCAS1
Convert All to Upper Case



@KBWCAS2
Convert All to Lower Case

E
xample

When the **Convert All to Lower Case** feature is enabled, barcode data "AbC" is transmitted as "abc".



If **Emulate ALT+Keypad ON** is selected, **Convert All to Lower Case** and **Convert All to Upper Case** do not function.



#SETUPE0
**** Exit Setup**



#SETUPE1
Enter Setup

Emulate Numeric Keypad



Do Not Emulate Numeric Keypad 1: Sending a number (0-9) is emulated as keystroke(s) on main keyboard.

Emulate Numeric Keypad 1: Sending a number (0-9) is emulated as keystroke(s) on numeric keypad. The state of Num Lock on the simulated numeric keypad is determined by its equivalent on the host device. If Num Lock on the host device is turned off, the output of simulated numeric keypad is function key instead of number.

Do Not Emulate Numeric Keypad 2: Sending “+”, “-”, “*” and “/” is emulated as keystroke(s) on main keyboard.

Emulate Numeric Keypad 2: Sending “+”, “-”, “*” and “/” is emulated as keystroke(s) on numeric keypad.



@KBWNUM0

**** Do Not Emulate Numeric Keypad 1**



@KBWNUM1

Emulate Numeric Keypad 1



#SETUPE0
**** Exit Setup**



#SETUPE1
Enter Setup



@KBWNCH0
**** Do Not Emulate Numeric Keypad 2**



@KBWNCH1
Emulate Numeric Keypad 2



Emulate ALT+Keypad ON prevails over **Emulate Numeric Keypad**.

E
sample

Supposing the **Emulate Numeric Keypad 1** and **Emulate Numeric Keypad 2** features are enabled:

if Num Lock on the host device is ON, "A4.5" is transmitted as "A4.5";

if Num Lock on the host device is OFF, "A4.5" is transmitted as follows:

1. "A" is sent as is because it is not included in numeric keypad;
2. "4" is sent as the function key "Cursor Move to Left";
3. "." is sent;
4. "5" is not sent as it does not correspond to any function key.

Finally the host device will get ".A"



#SETUPE0
**** Exit Setup**



#SETUPE1

Enter Setup

Character "+", "-", "*", "/" Adopt Numeric Keypad



@KBWNCH0

** Off



@KBWNCH1

On



#SETUPE0

** Exit Setup



#SETUPE1

Enter Setup

Fast Mode

When **Fast Mode On** is selected, the scanner sends characters to the host faster. If the host drops characters, turn the Fast Mode off or change the polling rate to a bigger value.



@KBWFAS0

**** Fast Mode Off**

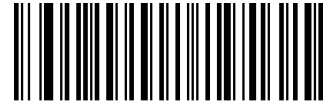

@KBWFAS1

Fast Mode On



#SETUPE0

**** Exit Setup**



#SETUPE1
Enter Setup

Polling Rate

This parameter specifies the polling rate for a USB keyboard. The smaller value rate is, the faster characters transmission from scanner to the host. If the host drops characters, change the polling rate to a bigger value.



@KBWPOR0
1ms

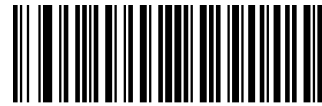

@KBWPOR1
2ms



@KBWPOR2
3ms

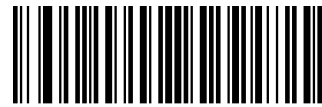

@KBWPOR3
****4ms**



@KBWPOR4
5ms



@KBWPOR5
6ms



@KBWPOR6
7ms



#SETUPE0
**** Exit Setup**



#SETUPE1

Enter Setup



@KBWPOR7

8ms



@KBWPOR8

9ms



@KBWPOR9

10ms



#SETUPE0

**** Exit Setup**



#SETUPE1
Enter Setup

Bluetooth Dongle CDC

In this is mode. the scanner equals to connect with the host via serial port



@INTERF17
Bluetooth Dongle CDC



#SETUPE0
**** Exit Setup**



#SETUPE1

Enter Setup

Bluetooth Dongle HID POS (POS HID Barcode Scanner)

Introduction

The HID-POS interface is recommended for new application programs. It can send up to 56 characters in a single USB report and appears more efficient than keyboard emulation.

Features:

1. HID based, no custom driver required.
2. More efficient in communication than keyboard emulation interface.



@INTERF18

Bluetooth Dongle HID-POS

Access the Scanner with Your Program

Use CreateFile to access the scanner as a HID device and then use ReadFile to deliver the scanned data to the application program. Use WriteFile to send data to the scanner.

For detailed information about USB and HID interfaces, go to www.USB.org.



#SETUPE0

**** Exit Setup**



#SETUPE1
Enter Setup

Acquire Scanned Data

After a barcode is decoded, the scanner sends an input report as below:

Byte	Bit							
	7	6	5	4	3	2	1	0
0	Report ID = 0x02							
1	Barcode Length							
2-57	Decoded Data (1-56)							
58-61	Reserved							
62	Newland Symbology Identifier or N/C: 0x00							
63	-	-	-	-	-	-	-	Decoded data continued

Send Command to the Scanner

This output report is used to send commands to the scanner. All programming commands can be used.

Byte	Bit							
	7	6	5	4	3	2	1	0
0	Report ID = 0x04							
1	Length of command							
2-63	Command (1-62)							



#SETUPE0
** Exit Setup



#SETUPE1

Enter Setup

VID/PID

USB uses VID (Vendor ID) and PID (Product ID) to identify and locate a device. The VID is assigned by USB Implementers Forum. Newland's vendor ID is 1EAB (Hex). A range of PIDs are used for each Newland product family. Every PID contains a base number and interface type (keyboard, COM port, etc.).

Product	Interface	PID (Hex)	PID (Dec)
HR3000-BT	Bluetooth Dongle KBW	3A22	14882
	Bluetooth Dongle HID POS	3A10	14864
	Bluetooth Dongle CDC	3A06	14854



#SETUPE0

**** Exit Setup**



#SETUPE1

Enter Setup

Default Setting of Wireless Communication

Clear Pairing Information of Scanner



@WLSCLP



#SETUPE0

**** Exit Setup**



#SETUPE1

Enter Setup

Operating Modes

The scanner provides the following operating modes:

Bluetooth HID/BLE mode allows the scanner to establish Bluetooth connection via Easyconnect.

Bluetooth HID Mode allows your scanner to communicate with a remote host using Bluetooth. You must first pair your scanner to the host before these two Bluetooth devices can communicate with each other. All features available for USB HID Keyboard are applicable to Bluetooth HID. Pressing the trigger twice can turn on/off iPhone and iPad's virtual keyboard.

Note: The pairing information in the scanner and the current host need to be cleared before connecting with other Bluetooth devices.

Scanner scan Clear Pairing Info on Scanner barcode, and the host delete the pairing information.

Bluetooth BLE Mode: The Bluetooth low energy communication mode can communicate with the host app developed based on the Bluetooth SDK. In this mode, the scanner provides a serial transparent transmission service based on GATT service.

Cradle Mode allows your scanner to communicate with a remote host by pairing with an HR3280-BT cradle. Cradle Mode is available only for pairing with the CD32 cardle shipped with the HR3280-BT-C



@INTERF10

Bluetooth HID Mode



@INTERF11

Bluetooth BLE



@INTERF12

Cradle Mode



#SETUPE0

** Exit Setup



#SETUPE1

Enter Setup

Batch Mode

Batch Mode Options

Off: The scanner attempts to transmit every barcode you scan. When you are out of service range, the scanned data will be lost.

Automatic Batch Mode: When in service range, the scanner attempts to transmit every barcode you scan. When out of range, the scanner stores the scanned data in the flash memory. Once you are back to service range, the scanner will automatically transmit the stored data and then remove it from the flash memory after transmission is done.

Manual Batch Mode: Scanned data will be stored in the flash memory no matter whether you are in service range or not. You may send the stored data to the host in either of the following ways: (i) press the Batch button on the cradle after inserting the scanner in cradle; or (ii) scan the Transmit Stored Data barcode. The scanner will automatically remove the stored data from the flash memory after transmission is done if the Auto Clear Stored Data after Transmission feature is turned on.

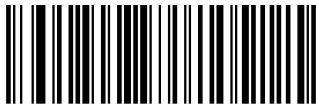

@WLSBAT0

****Off**



@WLSBAT1

Automatic Batch Mode

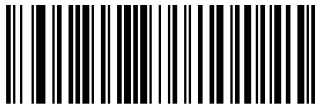

@WLSBAT2

Manual Batch Mode



#SETUPE0

**** Exit Setup**



#SETUPE1

Enter Setup

Prevent Same Barcode Storage

This feature is available only when scanning barcodes in the Automatic or Manual Batch mode.

On: The scanner discards the data and generates an error beep when encountering a barcode that has existed in the flash memory.

Off: The scanner stores the data when encountering a barcode that has existed in the flash memory.



@WLSSE0

**** Off**



@WLSSE1

On



#SETUPE0

**** Exit Setup**



#SETUPE1

Enter Setup

Batch Mode Transmit Delay

Sometimes when multiple barcodes stored in the flash memory are sent to the host, the transmission of those barcodes is too fast for the application to process. To program a transmit delay between barcodes, scan one of the following delays.



@WLSBTD0

**** No Transmit Delay (0ms)**



@WLSBTD50

Short Transmit Delay (50ms)



@WLSBTD100

Medium Transmit Delay (100ms)



@WLSBTD150

Long Transmit Delay (150ms)



@WLSBTD

Custom Transmit Delay (0-10,000ms)

E
xample

Set the batch mode transmit delay to 200ms:

1. Scan the **Enter Setup** barcode.
2. Scan the **Custom Transmit Delay** barcode.
3. Scan the numeric barcodes “2”, “0” and “0” from the “Digit Barcodes” section in Appendix.
4. Scan the **Save** barcode from the “Save/Cancel Barcodes” section in Appendix.
5. Scan the **Exit Setup** barcode.



#SETUPE0

**** Exit Setup**



#SETUPE1

Enter Setup

End of Transmission Message for Batch Mode

You may scan the appropriate barcode below to select whether or not to send an end of transmission message (user-programmable) to notify the host when transmission of all stored data is done. This feature is only available to data transmission initiated manually under the Manual Batch mode.



@WLSBTT0

**** End of Transmission Message Off**



@WLSBTT1

End of Transmission Message On

An end of transmission message can contain up to 10 characters (HEX values from 0x00 to 0xFF). To set an end of transmission message, scan the **Set End of Transmission Message** barcode, the numeric barcodes representing the hexadecimal values of desired character(s) and the **Save** barcode. The default setting is "EOT".



@WLSBTC

Set End of Transmission Message

E
xample

Set the end of transmission message to "END" (HEX: 0x45, 0x4E, 0x44):

1. Scan the **Enter Setup** barcode.
2. Scan the **Set End of Transmission Message** barcode.
3. Scan the numeric barcodes "4", "5", "4", "E", "4" and "4" from the "Digit Barcodes" section in Appendix.
4. Scan the **Save** barcode from the "Save/Cancel Barcodes" section in Appendix.
5. Scan the **Exit Setup** barcode.



#SETUPE0

**** Exit Setup**



#SETUPE1

Enter Setup

Transmit Stored Data

You may scan the barcode below to send the stored data in the flash memory to the host. This feature is only available to the Manual Batch mode.



@WSSBT

Transmit Stored Data

Auto Clear Stored Data after Transmission

You may scan the appropriate barcode below to choose whether to clear or keep the stored data in the flash memory after transmission. This feature is only available to the Manual Batch mode.



@WLSCLE0

**** Off**



@WLSCLE1

On

Query/Clear Stored Data in Flash



@WLSQFC

Query the Number of Stored Barcodes



@WLSCLF

Clear All Stored Data



#SETUPE0

**** Exit Setup**



#SETUPE1

Enter Setup

Auto Power-Off Timeout

Auto Power-off Timeout specifies the amount of time it takes before the scanner automatically powers off from inactivity.



@WLSAPO0

**** 5 Minutes**



@WLSAPO1

10 Minutes



@WLSAPO2

20 Mintues



@WLSAPO3

30 Mintues



@WLSAPO4

60 Minutes



@WLSAPO5

Disable Auto Power-off



#SETUPE0

**** Exit Setup**



#SETUPE1

Enter Setup

Set Scanner Name

You may scan the below barcode to set the name of your scanner. The maximum length is 5 characters (HEX values from 0x20 to 0x7E). The default scanner name is "00000".



@WLSNAM

Scanner Name

E
example

If setting the scanner name as "0AB00":

1. Scan the Enter Setup barcode
2. Scan the Scanner Name barcode
3. Scan the numeric barcode "3" "0" "4" "1" "4" "2" from the "Digit Barcodes" section in Appendix
4. Scan the **Save** barcode from the "Save/Cancel Barcodes" section in Appendix
5. Scan the Exit Setup barcode



#SETUPE0

**** Exit Setup**



#SETUPE1

Enter Setup

Set Date and Time



@WLSTMS

Set Date and Time

E
example

Set Date and Time to “20201021010101”:

1. Scan the **Enter Setup** barcode.
2. Scan the **Set Date and Time** barcode.
3. Scan the numeric barcodes “2”, “0”, “2”, “0”, “1”, “0”, “2”, “1”, “0”, “1”, “0”, “1”, “0” and “1” from the “Digit Barcodes” section in Appendix.
4. Scan the **Save** barcode from the “Save/Cancel Barcodes” section in Appendix.
5. Scan the **Exit Setup** barcode.

Query Current Date and Time

After scanning the barcode below, the current date and time in YYYYMMDDHHMMSS format will be sent to the host device.

For example, query result “20180205103011” means February 5th 2018 10:30:11.



@WLSTMQ

Query Current Date and Time



#SETUPE0

** Exit Setup



#SETUPE1

Enter Setup

Query Battery Status

Scan the below barcode, battery status will be showed in the host



@WLSQPW

Query Battery Status

Time Stamp

You can select whether or not to send date & time before each scanned data by scanning the appropriate barcode below.



@WLSTSE0

**** Do Not Send Time Stamp**



@WLSTSE1

Send Time Stamp



#SETUPE0

**** Exit Setup**



#SETUPE1

Enter Setup

Set Time Stamp Format



@WLSTSF0

**** Format 1: (YYYY/MM/DD, HH: MM: SS)**

(example: 2018/01/23, 10:30:20)



@WLSTSF1

Format 2: (DD/MM/YYYY/, HH: MM: SS)

(example: 23/01/2018, 10:30:20)



@WLSTSF2

Format 3: (MM/DD/YYYY,HH:MM:SS)

(example: 01/23/2018, 10:30:20)



#SETUPE0

**** Exit Setup**



#SETUPE1

Enter Setup

Chapter 5 Symbologies

Introduction

Every symbology (barcode type) has its own unique attributes. This chapter provides programming barcodes for configuring the scanner so that it can identify various symbologies. It is recommended to disable those that are rarely used to increase the efficiency of the scanner.

Global Settings

Enable/Disable All Symbologies

If the **Disable All Symbologies** feature is enabled, the scanner will not be able to read any non-programming barcodes except the programming barcodes.



@ALLENA1

Enable All Symbologies



@ALLENA0

Disable All Symbologies

Enable/Disable 1D Symbologies



@ALL1DC1

Enable 1D Symbologies



@ALL1DC0

Disable 1D Symbologies



#SETUPE0

** Exit Setup



#SETUPE1

Enter Setup

Enable/Disable 2D Symbologies



@ALL2DC1

Enable 2D Symbologies



@ALL2DC0

Disable 2D Symbologies

Enable/Disable Postal Symbologies



@ALLPST1

Enable All Postal Symbologies



@ALLPST0

Disable All Postal Symbologies



#SETUPE0

**** Exit Setup**



#SETUPE1
Enter Setup

Code 128

Restore Factory Defaults



@128DEF

****Restore the Factory Defaults of Code 128**

Enable/Disable Code 128



@128ENA1

**** Enable Code 128**



@128ENA0

Disable Code 128



If the scanner fails to identify Code 128 barcodes, you may first try this solution by scanning the **Enter Setup** barcode and then **Enable Code 128** barcode.



#SETUPE0
**** Exit Setup**



#SETUPE1
Enter Setup

Set Length Range for Code 128

The scanner can be configured to only decode Code 128 barcodes with lengths that fall between (inclusive) the minimum and maximum lengths. To accomplish it, you need to set the minimum and maximum lengths.



@128MIN

Set the Minimum Length (Default: 1)



@128MAX

Set the Maximum Length (Default: 48)



If minimum length is set to be greater than maximum length, the scanner only decodes Code 128 barcodes with either the minimum or maximum length. If minimum length is same as maximum length, only Code 128 barcodes with that length are to be decoded.



Set the scanner to decode Code 128 barcodes containing between 8 and 12 characters:

1. Scan the **Enter Setup** barcode.
2. Scan the **Set the Minimum Length** barcode.
3. Scan the numeric barcode “8” from the “Digit Barcodes” section in Appendix.
4. Scan the **Save** barcode from the “Save/Cancel Barcodes” section in Appendix.
5. Scan the **Set the Maximum Length** barcode.
6. Scan the numeric barcodes “1” and “2” from the “Digit Barcodes” section in Appendix.
7. Scan the **Save** barcode from the “Save/Cancel Barcodes” section in Appendix.
8. Scan the **Exit Setup** barcode.

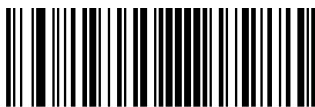

#SETUPE0
**** Exit Setup**



#SETUPE1
Enter Setup

EAN-8

Restore Factory Defaults



@EA8DEF

**** Restore the Factory Defaults of EAN-8**

Enable/Disable EAN-8



@EA8ENA1

**** Enable EAN-8**



@EA8ENA0

Disable EAN-8



If the scanner fails to identify EAN-8 barcodes, you may first try this solution by scanning the **Enter Setup** barcode and then **Enable EAN-8** barcode.

Transmit Check Character

EAN-8 is 8 digits in length with the last one as its check character used to verify the integrity of the data.



@EA8CHK2

**** Transmit EAN-8 Check Character**



@EA8CHK1

Do Not Transmit EAN-8 Check Character

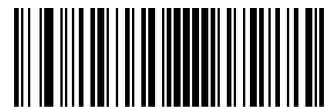

#SETUPE0
**** Exit Setup**



#SETUPE1
Enter Setup

2-Digit Add-On Code

An EAN-8 barcode can be augmented with a two-digit add-on code to form a new one. In the example below, the part surrounded by blue dotted line is an EAN-8 barcode while the part circled by red dotted line is a two-digit add-on code.



@EA8AD20
**** Disable 2-Digit Add-On Code**

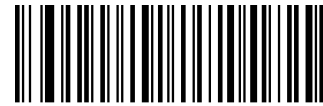

@EA8AD21
Enable 2-Digit Add-On Code



Disable 2-Digit Add-On Code: The scanner decodes EAN-8 and ignores the add-on code when presented with an EAN-8 plus 2-digit add-on barcode. It can also decode EAN-8 barcodes without 2-digit add-on codes.

Enable 2-Digit Add-On Code: The scanner decodes a mix of EAN-8 barcodes with and without 2-digit add-on codes.

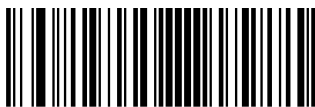

#SETUPE0
**** Exit Setup**



#SETUPE1

Enter Setup

5-Digit Add-On Code

An EAN-8 barcode can be augmented with a five-digit add-on code to form a new one. In the example below, the part surrounded by blue dotted line is an EAN-8 barcode while the part circled by red dotted line is a five-digit add-on code.



@EA8AD50

** Disable 5-Digit Add-On Code



@EA8AD51

Enable 5-Digit Add-On Code



Disable 5-Digit Add-On Code: The scanner decodes EAN-8 and ignores the add-on code when presented with an EAN-8 plus 5-digit add-on barcode. It can also decode EAN-8 barcodes without 5-digit add-on codes.

Enable 5-Digit Add-On Code: The scanner decodes a mix of EAN-8 barcodes with and without 5-digit add-on codes.



#SETUPE0

** Exit Setup



#SETUPE1
Enter Setup

Add-On Code Required

When **EAN-8 Add-On Code Required** is selected, the scanner will only read EAN-8 barcodes that contain add-on codes.



@EA8REQ0

** EAN-8 Add-On Code Not Required



@E13REQ1

EAN-8 Add-On Code Required

Convert EAN-8 to EAN-13

Convert EAN-8 to EAN-13: Convert EAN-8 decoded data to EAN-13 format before transmission. After conversion, the data follows EAN-13 format and is affected by EAN-13 programming selections (e.g., Check Character).

Do Not Convert EAN-8 to EAN-13: EAN-8 decoded data is transmitted as EAN-8 data, without conversion.



@EA8EXP0

** Do Not Convert EAN-8 to EAN-13



@EA8EXP1

Convert EAN-8 to EAN-13



#SETUPE0
** Exit Setup



#SETUPE1
Enter Setup

EAN-13

Restore Factory Defaults



@E13DEF

** Restore the Factory Defaults of EAN-13

Enable/Disable EAN-13



@E13ENA1

** Enable EAN-13



@E13ENA0

Disable EAN-13



If the scanner fails to identify EAN-13 barcodes, you may first try this solution by scanning the **Enter Setup** barcode and then **Enable EAN-13** barcode.



#SETUPE0
** Exit Setup



#SETUPE1
Enter Setup

Transmit Check Character



@E13CHK2

** Transmit EAN-13 Check Character



@E13CHK1

Do Not Transmit EAN-13 Check Character

2-Digit Add-On Code

An EAN-13 barcode can be augmented with a two-digit add-on code to form a new one. In the example below, the part surrounded by blue dotted line is an EAN-13 barcode while the part circled by red dotted line is a two-digit add-on code.



@E13AD20

** Disable 2-Digit Add-On Code



@E13AD21

Enable 2-Digit Add-On Code



Disable 2-Digit Add-On Code: The scanner decodes EAN-13 and ignores the add-on code when presented with an EAN-13 plus 2-digit add-on barcode. It can also decode EAN-13 barcodes without 2-digit add-on codes.

Enable 2-Digit Add-On Code: The scanner decodes a mix of EAN-13 barcodes with and without 2-digit add-on codes.



#SETUPE0
** Exit Setup



#SETUPE1

Enter Setup

5-Digit Add-On Code

An EAN-13 barcode can be augmented with a five-digit add-on code to form a new one. In the example below, the part surrounded by blue dotted line is an EAN-13 barcode while the part circled by red dotted line is a five-digit add-on code.



@E13AD50

** Disable 5-Digit Add-On Code



@E13AD51

Enable 5-Digit Add-On Code



Disable 5-Digit Add-On Code: The scanner decodes EAN-13 and ignores the add-on code when presented with an EAN-13 plus 5-digit add-on barcode. It can also decode EAN-13 barcodes without 5-digit add-on codes.

Enable 5-Digit Add-On Code: The scanner decodes a mix of EAN-13 barcodes with and without 5-digit add-on codes.

Add-On Code Required

When **EAN-13 Add-On Code Required** is selected, the scanner will only read EAN-13 barcodes that contain add-on codes.



@E13REQ0

** EAN-13 Add-On Code Not Required



@E13REQ1

EAN-13 Add-On Code Required

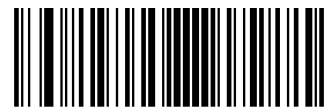

#SETUPE0

** Exit Setup



#SETUPE1
Enter Setup

EAN-13 Beginning with 290 Add-On Code Required

This setting programs the scanner to require an add-on code (2-digit or 5-digit) on EAN-13 barcodes that begin with “290”. The following settings can be programmed:

Require Add-On Code: All EAN-13 barcodes that begin with “290” must have a 2-digit or 5-digit add-on code. The EAN-13 barcode with the add-on code is then transmitted. If the required add-on code is not found, the EAN-13 barcode is discarded.

Do Not Require Add-On Code: If you have selected **Require Add-On Code**, and you want to disable this feature, scan **Do Not Require Add-On Code**. EAN-13 barcodes are handled, depending on your selection for the “Add-On Code Required” feature.



** Do Not Require Add-On Code



Require Add-On Code

EAN-13 Beginning with 378/379 Add-On Code Required

This setting programs the scanner to require an add-on code (2-digit or 5-digit) on EAN-13 barcodes that begin with a “378” or “379”. The following settings can be programmed:

Require Add-On Code: All EAN-13 barcodes that begin with a “378” or “379” must have a 2-digit or 5-digit add-on code. The EAN-13 barcode with the add-on code is then transmitted. If the required add-on code is not found, the EAN-13 barcode is discarded.

Do Not Require Add-On Code: If you have selected **Require Add-On Code**, and you want to disable this feature, scan **Do Not Require Add-On Code**. EAN-13 barcodes are handled, depending on your selection for the “Add-On Code Required” feature.



** Do Not Require Add-On Code



Require Add-On Code



#SETUPE0
** Exit Setup



#SETUPE1

Enter Setup

EAN-13 Beginning with 414/419 Add-On Code Required

This setting programs the scanner to require an add-on code (2-digit or 5-digit) on EAN-13 barcodes that begin with a “414” or “419”. The following settings can be programmed:

Require Add-On Code: All EAN-13 barcodes that begin with a “414” or “419” must have a 2-digit or 5-digit add-on code. The EAN-13 barcode with the add-on code is then transmitted. If the required add-on code is not found, the EAN-13 barcode is discarded.

Do Not Require Add-On Code: If you have selected **Require Add-On Code**, and you want to disable this feature, scan **Do Not Require Add-On Code**. EAN-13 barcodes are handled, depending on your selection for the “Add-On Code Required” feature.



@E134140

**** Do Not Require Add-On Code**



@E134141

Require Add-On Code

EAN-13 Beginning with 434/439 Add-On Code Required

This setting programs the scanner to require an add-on code (2-digit or 5-digit) on EAN-13 barcodes that begin with a “434” or “439”. The following settings can be programmed:

Require Add-On Code: All EAN-13 barcodes that begin with a “434” or “439” must have a 2-digit or 5-digit add-on code. The EAN-13 barcode with the add-on code is then transmitted. If the required add-on code is not found, the EAN-13 barcode is discarded.

Do Not Require Add-On Code: If you have selected **Require Add-On Code**, and you want to disable this feature, scan **Do Not Require Add-On Code**. EAN-13 barcodes are handled, depending on your selection for the “Add-On Code Required” feature.



@E134340

**** Do Not Require Add-On Code**



@E134341

Require Add-On Code



#SETUPE0

**** Exit Setup**



#SETUPE1
Enter Setup

EAN-13 Beginning with 977 Add-On Code Required

This setting programs the scanner to require an add-on code (2-digit or 5-digit) on EAN-13 barcodes that begin with “977”. The following settings can be programmed:

Require Add-On Code: All EAN-13 barcodes that begin with “977” must have a 2-digit or 5-digit add-on code. The EAN-13 barcode with the add-on code is then transmitted. If the required add-on code is not found, the EAN-13 barcode is discarded.

Do Not Require Add-On Code: If you have selected **Require Add-On Code**, and you want to disable this feature, scan **Do Not Require Add-On Code**. EAN-13 barcodes are handled, depending on your selection for the “Add-On Code Required” feature.



**** Do Not Require Add-On Code**



Require Add-On Code

EAN-13 Beginning with 978 Add-On Code Required

This setting programs the scanner to require an add-on code (2-digit or 5-digit) on EAN-13 barcodes that begin with “978”. The following settings can be programmed:

Require Add-On Code: All EAN-13 barcodes that begin with “978” must have a 2-digit or 5-digit add-on code. The EAN-13 barcode with the add-on code is then transmitted. If the required add-on code is not found, the EAN-13 barcode is discarded.

Do Not Require Add-On Code: If you have selected **Require Add-On Code**, and you want to disable this feature, scan **Do Not Require Add-On Code**. EAN-13 barcodes are handled, depending on your selection for the “Add-On Code Required” feature.



**** Do Not Require Add-On Code**



Require Add-On Code



#SETUPE0
**** Exit Setup**



#SETUPE1

Enter Setup

EAN-13 Beginning with 979 Add-On Code Required

This setting programs the scanner to require an add-on code (2-digit or 5-digit) on EAN-13 barcodes that begin with “979”. The following settings can be programmed:

Require Add-On Code: All EAN-13 barcodes that begin with “979” must have a 2-digit or 5-digit add-on code. The EAN-13 barcode with the add-on code is then transmitted. If the required add-on code is not found, the EAN-13 barcode is discarded.

Do Not Require Add-On Code: If you have selected **Require Add-On Code**, and you want to disable this feature, scan **Do Not Require Add-On Code**. EAN-13 barcodes are handled, depending on your selection for the “Add-On Code Required” feature.



@E139790

**** Do Not Require Add-On Code**



@E139791

Require Add-On Code



#SETUPE0

**** Exit Setup**



#SETUPE1
Enter Setup

UPC-E

Restore Factory Defaults



@UPEDEF

** Restore the Factory Defaults of UPC-E

Enable/Disable UPC-E



@UPEENA1
** Enable UPC-E



@UPEENA0
Disable UPC-E



#SETUPE0
** Exit Setup



#SETUPE1
Enter Setup

Enable/Disable UPC-E0



@UPEEN01
**** Enable UPC-E0**



@UPEEN00
Disable UPC-E0

Enable/Disable UPC-E1



@UPEEN11
Enable UPC-E1



@UPEEN10
**** Disable UPC-E1**



If the scanner fails to identify UPC-E0/UPC-E1 barcodes, you may first try this solution by scanning the **Enter Setup** barcode and then **Enable UPC-E0/UPC-E1** barcode.



#SETUPE0
**** Exit Setup**



#SETUPE1
Enter Setup

Transmit Check Character

UPC-E is 8 digits in length with the last one as its check character used to verify the integrity of the data.



@UPECHK2
**** Transmit UPC-E Check Character**



@UPECHK1
Do Not Transmit UPC-E Check Character

2-Digit Add-On Code

A UPC-E barcode can be augmented with a two-digit add-on code to form a new one. In the example below, the part surrounded by blue dotted line is a UPC-E barcode while the part circled by red dotted line is a two-digit add-on code.



@UPEAD20
**** Disable 2-Digit Add-On Code**



@UPEAD21
Enable 2-Digit Add-On Code



Disable 2-Digit Add-On Code: The scanner decodes UPC-E and ignores the add-on code when presented with a UPC-E plus 2-digit add-on barcode. It can also decode UPC-E barcodes without 2-digit add-on codes.

Enable 2-Digit Add-On Code: The scanner decodes a mix of UPC-E barcodes with and without 2-digit add-on codes.



#SETUPE0
**** Exit Setup**



#SETUPE1

Enter Setup

5-Digit Add-On Code

A UPC-E barcode can be augmented with a five-digit add-on code to form a new one. In the example below, the part surrounded by blue dotted line is a UPC-E barcode while the part circled by red dotted line is a five-digit add-on code.



@UPEAD50

** Disable 5-Digit Add-On Code



@UPEAD51

Enable 5-Digit Add-On Code



Disable 5-Digit Add-On Code: The scanner decodes UPC-E and ignores the add-on code when presented with a UPC-E plus 5-digit add-on barcode. It can also decode UPC-E barcodes without 5-digit add-on codes.

Enable 5-Digit Add-On Code: The scanner decodes a mix of UPC-E barcodes with and without 5-digit add-on codes.



#SETUPE0

** Exit Setup



#SETUPE1
Enter Setup

Add-On Code Required

When **UPC-E Add-On Code Required** is selected, the scanner will only read UPC-E barcodes that contain add-on codes.



@UPEREQ0
**** UPC-E Add-On Code Not Required**



@UPEREQ1
UPC-E Add-On Code Required

Transmit Preamble Character

Preamble characters (Country Code and System Character) can be transmitted as part of a UPC-E barcode. Select one of the following options for transmitting UPC-E preamble to the host device: transmit system character only, transmit system character and country code ("0" for USA), or transmit no preamble.



@UPEPRE1
**** System Character**



@UPEPRE0
No Preamble



@UPEPRE2
System Character & Country Code



#SETUPE0
**** Exit Setup**



#SETUPE1

Enter Setup

Convert UPC-E to UPC-A

Convert UPC-E to UPC-A: Convert UPC-E (zero suppressed) decoded data to UPC-A format before transmission. After conversion, the data follows UPC-A format and is affected by UPC-A programming selections (e.g., Preamble, Check Character).

Do Not Convert UPC-E to UPC-A: UPC-E decoded data is transmitted as UPC-E data, without conversion.



@UPEEXP0

**** Do Not Convert UPC-E to UPC-A**



@UPEEXP1

Convert UPC-E to UPC-A



#SETUPE0

**** Exit Setup**



#SETUPE1
Enter Setup

UPC-A

Restore Factory Defaults



@UPADEF
Restore the Factory Defaults of UPC-A

Enable/Disable UPC-A



@UPAENA1
**** Enable UPC-A**



@UPAENA0
Disable UPC-A



If the scanner fails to identify UPC-A barcodes, you may first try this solution by scanning the **Enter Setup** barcode and then **Enable UPC-A** barcode.



#SETUPE0
**** Exit Setup**



#SETUPE1

Enter Setup

Transmit Check Character

UPC-A is 13 digits in length with the last one as its check character used to verify the integrity of the data.



@UPACHK2

**** Transmit UPC-A Check Character**

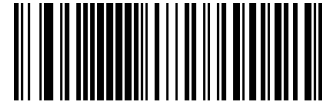

@UPACHK1

Do Not Transmit UPC-A Check Character



#SETUPE0

**** Exit Setup**



#SETUPE1
Enter Setup

2-Digit Add-On Code

A UPC-A barcode can be augmented with a two-digit add-on code to form a new one. In the example below, the part surrounded by blue dotted line is a UPC-A barcode while the part circled by red dotted line is a two-digit add-on code.



@UPAAD20
**** Disable 2-Digit Add-On Code**



@UPAAD21
Enable 2-Digit Add-On Code



Disable 2-Digit Add-On Code: The scanner decodes UPC-A and ignores the add-on code when presented with a UPC-A plus 2-digit add-on barcode. It can also decode UPC-A barcodes without 2-digit add-on codes.

Enable 2-Digit Add-On Code: The scanner decodes a mix of UPC-A barcodes with and without 2-digit add-on codes.



#SETUPE0
**** Exit Setup**



#SETUPE1

Enter Setup

5-Digit Add-On Code

A UPC-A barcode can be augmented with a five-digit add-on code to form a new one. In the example below, the part surrounded by blue dotted line is a UPC-A barcode while the part circled by red dotted line is a five-digit add-on code.



@UPAAD50

**** Disable 5-Digit Add-On Code**



@UPAAD51

Enable 5-Digit Add-On Code



Disable 5-Digit Add-On Code: The scanner decodes UPC-A and ignores the add-on code when presented with a UPC-A plus 5-digit add-on barcode. It can also decode UPC-A barcodes without 5-digit add-on codes.

Enable 5-Digit Add-On Code: The scanner decodes a mix of UPC-A barcodes with and without 5-digit add-on codes.



#SETUPE0

**** Exit Setup**



#SETUPE1
Enter Setup

Add-On Code Required

When **UPC-A Add-On Code Required** is selected, the scanner will only read UPC-A barcodes that contain add-on codes.



@UPAREQ0

**** UPC-A Add-On Code Not Required**

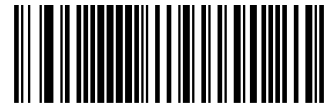

@UPAREQ1

UPC-A Add-On Code Required

Transmit Preamble Character

Preamble characters (Country Code and System Character) can be transmitted as part of a UPC-A barcode. Select one of the following options for transmitting UPC-A preamble to the host device: transmit system character only, transmit system character and country code ("0" for USA), or transmit no preamble.



@UPAPRE0

****No Preamble**



@UPAPRE1

System Character



@UPAPRE2

System Character & Country Code



#SETUPE0
**** Exit Setup**



#SETUPE1

Enter Setup

Coupon

UPC-A/EAN-13 with Extended Coupon Code

The following three types of coupon code + extended coupon code are supported:

- ◇ UPC-A (starting with “5”) + GS1-128
- ◇ UPC-A (starting with “5”) + GS1 Databar
- ◇ EAN-13 (starting with “99”) + GS1-128

Use the appropriate barcode below to enable or disable UPC-A/EAN-13 with Extended Coupon Code. When left on the default setting (**Off**), the scanner treats Coupon Codes and Extended Coupon Codes as single barcodes.

If you scan the **Allow Concatenation** code, when the scanner sees the coupon code and the extended coupon code in a single scan, it transmits both as separate symbologies. Otherwise, it transmits the first coupon code it reads.

If you scan the **Require Concatenation** code, the scanner must see and read the coupon code and extended coupon code in a single read to transmit the data. No data is output unless both codes are read.



@CPNENA0

** Off



@CPNENA1

Allow Concatenation



@CPNENA2

Require Concatenation



When using the UPC-A Coupon feature, please ensure that **System Character** or **System Character & Country Code** is selected for the “Transmit UPC-A Preamble Character” feature.



#SETUPE0

** Exit Setup



#SETUPE1
Enter Setup

Coupon GS1 Databar Output

If you scan coupons that have both UPC and GS1 Databar codes, you may wish to scan and output only the data from the GS1 Databar code. Scan the **GS1 Output On** barcode below to scan and output only the GS1 Databar code data.

When **GS1 Output Off** is selected, coupons that have both UPC and GS1 Databar codes are transmitted depending on your selection for the “UPC-A/EAN-13 with Extended Coupon Code” feature.



@CPNGS10
**** GS1 Output Off**



@CPNGS11
GS1 Output On



When using the UPC-A Coupon feature, please ensure that **System Character** or **System Character & Country Code** is selected for the “Transmit UPC-A Preamble Character” feature.



#SETUPE0
**** Exit Setup**



#SETUPE1
Enter Setup

Interleaved 2 of 5

Restore Factory Defaults



@I25DEF

Restore the Factory Defaults of Interleaved 2 of 5

Enable/Disable Interleaved 2 of 5



@I25ENA1

** Enable Interleaved 2 of 5



@I25ENA0

Disable Interleaved 2 of 5



If the scanner fails to identify Interleaved 2 of 5 barcodes, you may first try this solution by scanning the **Enter Setup** barcode and then **Enable Interleaved 2 of 5** barcode.



#SETUPE0
** Exit Setup



#SETUPE1
Enter Setup

Set Length Range for Interleaved 2 of 5

The scanner can be configured to only decode Interleaved 2 of 5 barcodes with lengths that fall between (inclusive) the minimum and maximum lengths. To accomplish it, you need to set the minimum and maximum lengths.



@I25MIN

Set the Minimum Length (Default: 6)



@I25MAX

Set the Maximum Length (Default: 80)



If minimum length is set to be greater than maximum length, the scanner only decodes Interleaved 2 of 5 barcodes with either the minimum or maximum length. If minimum length is same as maximum length, only Interleaved 2 of 5 barcodes with that length are to be decoded.



Set the scanner to decode Interleaved 2 of 5 barcodes containing between 8 and 12 characters:

1. Scan the **Enter Setup** barcode.
2. Scan the **Set the Minimum Length** barcode.
3. Scan the numeric barcode “8” from the “Digit Barcodes” section in Appendix.
4. Scan the **Save** barcode from the “Save/Cancel Barcodes” section in Appendix.
5. Scan the **Set the Maximum Length** barcode.
6. Scan the numeric barcodes “1” and “2” from the “Digit Barcodes” section in Appendix.
7. Scan the **Save** barcode from the “Save/Cancel Barcodes” section in Appendix.
8. Scan the **Exit Setup** barcode.

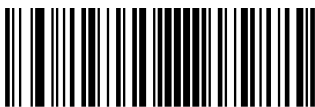

#SETUPE0
**** Exit Setup**



#SETUPE1

Enter Setup

Safety Level

High Safety Level can improve decoding performance



@I25SEC0

** Interleaved 2 of 5 Level 1



@I25SEC2

Interleaved 2 of 5 Level 3



@I25SEC1

Interleaved 2 of 5 Level 2



@I25SEC3

Interleaved 2 of 5 Level 4

High Safety Level can improve decoding performance but slow decoding speed



#SETUPE0

** Exit Setup



#SETUPE1
Enter Setup

Check Character Verification

A check character is optional for Interleaved 2 of 5 and can be added as the last character. It is a calculated value used to verify the integrity of the data.

- ◇ **Disable:** The scanner transmits Interleaved 2 of 5 barcodes as is.
- ◇ **Do Not Transmit Check Character After Verification:** The scanner checks the integrity of all Interleaved 2 of 5 barcodes to verify that the data complies with the check character algorithm. Barcodes passing the check will be transmitted except the last digit, whereas those failing it will not be transmitted.
- ◇ **Transmit Check Character After Verification:** The scanner checks the integrity of all Interleaved 2 of 5 barcodes to verify that the data complies with the check character algorithm. Barcodes passing the check will be transmitted, whereas those failing it will not be transmitted.

Since Interleaved 2 of 5 must always have an even number of digits, a zero may need to be added as the first digit when the check character is added. The check character is automatically generated when making Interleaved 2 of 5 barcodes.



@I25CHK0
** Disable



@I25CHK1

Do Not Transmit Check Character After Verification



@I25CHK2

Transmit Check Character After Verification



If the **Do Not Transmit Check Character After Verification** option is enabled, Interleaved 2 of 5 barcodes with a length that is less than the configured minimum length after having the check character excluded will not be decoded. (For example, when the **Do Not Transmit Check Character After Verification** option is enabled and the minimum length is set to 4, Interleaved 2 of 5 barcodes with a total length of 4 characters including the check character cannot be read.)



#SETUPE0
** Exit Setup



#SETUPE1

Enter Setup

Febraban

Disable/Enable Febraban



@I25FBB0

** Disable Febraban



@I25FBB2

Enable Febraban, Expand



@I25FBB1

Enable Febraban, Do Not Expand

Transmit Delay per Character

Transmit Delay per Character applies to both Expanded and Unexpanded Febraban. This feature is available only when USB HID Keyboard is enabled.



@FEBSNO

** Disable Transmit Delay per Character



@FEBSN1

Enable Transmit Delay per Character



#SETUPE0

** Exit Setup



#SETUPE1
Enter Setup

You may select an appropriate delay value from the options below as per your actual needs.



@FEBSDT0
0ms



@FEBSDT5
5ms



@FEBSDT10
10ms



@FEBSDT15
15ms



@FEBSDT20
20ms



@FEBSDT25
25ms



@FEBSDT30
30ms



@FEBSDT35
35ms



#SETUPE0
**** Exit Setup**



#SETUPE1
Enter Setup



@FEBSDT40
40ms



@FEBSDT45
45ms



@FEBSDT50
50ms



@FEBSDT55
55ms



@FEBSDT60
60ms



@FEBSDT65
65ms

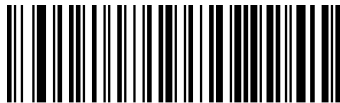

@FEBSDT70
** 70ms



@FEBSDT75
75ms

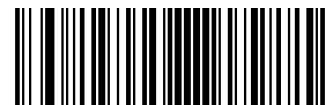

#SETUPE0
** Exit Setup



#SETUPE1
Enter Setup

Transmit Delay per 12 Characters

Transmit Delay per 12 Characters applies to Expanded Febraban only. This feature is available only when USB HID Keyboard is enabled.



@FEBMENO

** Disable Transmit Delay per 12 Characters



@FEBMEN1

Enable Transmit Delay per 12 Characters

You may select an appropriate delay value from the options below as per your actual needs.



@FEBMDT0

0ms



@FEBMDT1

300ms



@FEBMDT2

400ms



#SETUPE0
** Exit Setup



#SETUPE1
Enter Setup



@FEBMDT3
**** 500ms**

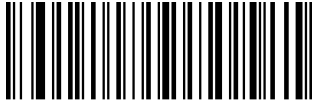

@FEBMDT4
600ms

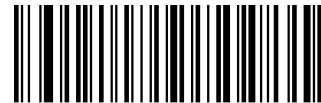

@FEBMDT5
700ms



@FEBMDT6
800ms



@FEBMDT7
900ms



#SETUPE0
**** Exit Setup**



#SETUPE1
Enter Setup

ITF-14

ITF-14 is a special kind of Interleaved 2 of 5 with a length of 14 characters and the last character as the check character.

ITF-14 priority principle: For the Interleaved 2 of 5 barcodes with a length of 14 characters and the last character as the check character, the ITF-14 configurations shall take precedence over the Interleaved 2 of 5 settings.

Restore Factory Defaults



@I14DEF

Restore the Factory Defaults of ITF-14

Enable/Disable ITF-14



@I14ENA0

** Disable ITF-14



@I14ENA1

Enable ITF-14 But Do Not Transmit Check Character



@I14ENA2

Enable ITF-14 and Transmit Check Character



An example of the ITF-14 priority principle: when ITF-14 is enabled and Interleaved 2 of 5 is disabled, the scanner only decodes Interleaved 2 of 5 barcodes with a length of 14 characters and the last character as the check character.



#SETUPE0
** Exit Setup



#SETUPE1

Enter Setup

ITF-6

ITF-6 is a special kind of Interleaved 2 of 5 with a length of 6 characters and the last character as the check character.

ITF-6 priority principle: For the Interleaved 2 of 5 barcodes with a length of 6 characters and the last character as the check character, the ITF-6 configurations shall take precedence over the Interleaved 2 of 5 settings.

Restore Factory Defaults



@IT6DEF

Restore the Factory Defaults of ITF-6

Enable/Disable ITF-6



@IT6ENA0

**** Disable ITF-6**

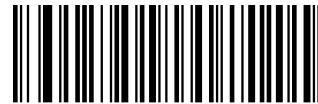

@IT6ENA1

Enable ITF-6 But Do Not Transmit Check Character



@IT6ENA2

Enable ITF-6 and Transmit Check Character



An example of the ITF-6 priority principle: when ITF-6 is enabled and Interleaved 2 of 5 is disabled, the scanner only decodes Interleaved 2 of 5 barcodes with a length of 6 characters and the last character as the check character.



#SETUPE0

**** Exit Setup**



#SETUPE1
Enter Setup

Matrix 2 of 5

Restore Factory Defaults



@M25DEF
Restore the Factory Defaults of Matrix 2 of 5

Enable/Disable Matrix 2 of 5



@M25ENA1
**** Enable Matrix 2 of 5**



@M25ENA0
Disable Matrix 2 of 5



If the scanner fails to identify Matrix 2 of 5 barcodes, you may first try this solution by scanning the **Enter Setup** barcode and then **Enable Matrix 2 of 5** barcode.

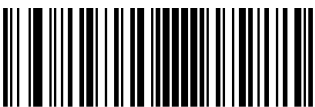

#SETUPE0
**** Exit Setup**



#SETUPE1

Enter Setup

Set Length Range for Matrix 2 of 5

The scanner can be configured to only decode Matrix 2 of 5 barcodes with lengths that fall between (inclusive) the minimum and maximum lengths. To accomplish it, you need to set the minimum and maximum lengths.



@M25MIN

Set the Minimum Length (Default: 4)



@M25MAX

Set the Maximum Length (Default: 80)



If minimum length is set to be greater than maximum length, the scanner only decodes Matrix 2 of 5 barcodes with either the minimum or maximum length. If minimum length is same as maximum length, only Matrix 2 of 5 barcodes with that length are to be decoded.



Set the scanner to decode Matrix 2 of 5 barcodes containing between 8 and 12 characters:

1. Scan the **Enter Setup** barcode.
2. Scan the **Set the Minimum Length** barcode.
3. Scan the numeric barcode “8” from the “Digit Barcodes” section in Appendix.
4. Scan the **Save** barcode from the “Save/Cancel Barcodes” section in Appendix.
5. Scan the **Set the Maximum Length** barcode.
6. Scan the numeric barcodes “1” and “2” from the “Digit Barcodes” section in Appendix.
7. Scan the **Save** barcode from the “Save/Cancel Barcodes” section in Appendix.
8. Scan the **Exit Setup** barcode.



#SETUPE0

**** Exit Setup**



#SETUPE1
Enter Setup

Check Character Verification

A check character is optional for Matrix 2 of 5 and can be added as the last character. It is a calculated value used to verify the integrity of the data.

- ◇ **Disable:** The scanner transmits Matrix 2 of 5 barcodes as is.
- ◇ **Do Not Transmit Check Character After Verification:** The scanner checks the integrity of all Matrix 2 of 5 barcodes to verify that the data complies with the check character algorithm. Barcodes passing the check will be transmitted except the last digit, whereas those failing it will not be transmitted.
- ◇ **Transmit Check Character After Verification:** The scanner checks the integrity of all Matrix 2 of 5 barcodes to verify that the data complies with the check character algorithm. Barcodes passing the check will be transmitted, whereas those failing it will not be transmitted.

Since Matrix 2 of 5 must always have an even number of digits, a zero may need to be added as the first digit when the check character is added. The check character is automatically generated when making Matrix 2 of 5 barcodes.



@M25CHK0
** Disable



@M25CHK1

Do Not Transmit Check Character After Verification



@M25CHK2

Transmit Check Character After Verification



If the **Do Not Transmit Check Character After Verification** option is enabled, Matrix 2 of 5 barcodes with a length that is less than the configured minimum length after having the check character excluded will not be decoded. (For example, when the **Do Not Transmit Check Character After Verification** option is enabled and the minimum length is set to 4, Matrix 2 of 5 barcodes with a total length of 4 characters including the check character cannot be read.)



#SETUPE0
** Exit Setup



#SETUPE1
Enter Setup

Code 39

Restore Factory Defaults



@C39DEF
Restore the Factory Defaults of Code 39

Enable/Disable Code 39



@C39ENA1
**** Enable Code 39**



@C39ENA0
Disable Code 39



If the scanner fails to identify Code 39 barcodes, you may first try this solution by scanning the **Enter Setup** barcode and then **Enable Code 39** barcode.



#SETUPE0
**** Exit Setup**



#SETUPE1
Enter Setup

Set Length Range for Code 39

The scanner can be configured to only decode Code 39 barcodes with lengths that fall between (inclusive) the minimum and maximum lengths. To accomplish it, you need to set the minimum and maximum lengths.



@C39MIN

Set the Minimum Length (Default: 1)



@C39MAX

Set the Maximum Length (Default: 48)



If minimum length is set to be greater than maximum length, the scanner only decodes Code 39 barcodes with either the minimum or maximum length. If minimum length is same as maximum length, only Code 39 barcodes with that length are to be decoded.

Example

Set the scanner to decode Code 39 barcodes containing between 8 and 12 characters:

1. Scan the **Enter Setup** barcode.
2. Scan the **Set the Minimum Length** barcode.
3. Scan the numeric barcode “8” from the “Digit Barcodes” section in Appendix.
4. Scan the **Save** barcode from the “Save/Cancel Barcodes” section in Appendix.
5. Scan the **Set the Maximum Length** barcode.
6. Scan the numeric barcodes “1” and “2” from the “Digit Barcodes” section in Appendix.
7. Scan the **Save** barcode from the “Save/Cancel Barcodes” section in Appendix.
8. Scan the **Exit Setup** barcode.



#SETUPE0
** Exit Setup



#SETUPE1

Enter Setup

Check Character Verification

A check character is optional for Code 39 and can be added as the last character. It is a calculated value used to verify the integrity of the data.

- ◇ **Disable:** The scanner transmits Code 39 barcodes as is.
- ◇ **Do Not Transmit Check Character After Verification:** The scanner checks the integrity of all Code 39 barcodes to verify that the data complies with the check character algorithm. Barcodes passing the check will be transmitted except the last digit, whereas those failing it will not be transmitted.
- ◇ **Transmit Check Character After Verification:** The scanner checks the integrity of all Code 39 barcodes to verify that the data complies with the check character algorithm. Barcodes passing the check will be transmitted, whereas those failing it will not be transmitted.



@C39CHK0

** Disable



@C39CHK1

Do Not Transmit Check Character After Verification



@C39CHK2

Transmit Check Character After Verification



If the **Do Not Transmit Check Character After Verification** option is enabled, Code 39 barcodes with a length that is less than the configured minimum length after having the check character excluded will not be decoded. (For example, when the **Do Not Transmit Check Character After Verification** option is enabled and the minimum length is set to 4, Code 39 barcodes with a total length of 4 characters including the check character cannot be read.)



#SETUPE0

** Exit Setup



#SETUPE1
Enter Setup

Transmit Start/Stop Character

Code 39 uses an asterisk (*) for both the start and the stop characters. You can choose whether or not to transmit the start/stop characters by scanning the appropriate barcode below.



@C39TSC0

**** Do Not Transmit Start/Stop Character**



@C39TSC1

Transmit Start/Stop Character

Enable/Disable Code 39 Full ASCII

The scanner can be configured to identify all ASCII characters by scanning the appropriate barcode below.



@C39ASC0

**** Disable Code 39 Full ASCII**



@C39ASC1

Enable Code 39 Full ASCII



#SETUPE0
**** Exit Setup**



#SETUPE1

Enter Setup

Enable/Disable Code 32 (Italian Pharma Code)

Code 32 is a variant of Code 39 used by the Italian pharmaceutical industry. Scan the appropriate barcode below to enable or disable Code 32. Code 39 must be enabled and Code 39 check character verification must be disabled for this parameter to function.



@C39E320

**** Disable Code 32**



@C39E321

Enable Code 32

Code 32 Prefix

You may scan the appropriate barcode below to enable or disable adding the prefix character "A" to all Code 32 barcodes. Code 32 must be enabled for this parameter to function.



@C39S320

**** Disable Code 32 Prefix**



@C39S321

Enable Code 32 Prefix



#SETUPE0

**** Exit Setup**



#SETUPE1
Enter Setup

Transmit Code 32 Start/Stop Character

Code 32 must be enabled for this parameter to function.



@C39T320

** Do Not Transmit Code 32 Start/Stop Character



@C39T321

Transmit Code 32 Start/Stop Character

Transmit Code 32 Check Character

Code 32 must be enabled for this parameter to function.



@C39C320

** Do Not Transmit Code 32 Check Character



@C39C321

Transmit Code 32 Check Character



#SETUPE0
** Exit Setup



#SETUPE1
Enter Setup

Codabar

Restore Factory Defaults



@CBADEF
Restore the Factory Defaults of Codabar

Enable/Disable Codabar



@CBAENA1
**** Enable Codabar**



@CBAENA0
Disable Codabar



If the scanner fails to identify Codabar barcodes, you may first try this solution by scanning the **Enter Setup** barcode and then **Enable Codabar** barcode.



#SETUPE0
**** Exit Setup**



#SETUPE1
Enter Setup

Set Length Range for Codabar

The scanner can be configured to only decode Codabar barcodes with lengths that fall between (inclusive) the minimum and maximum lengths. To accomplish it, you need to set the minimum and maximum lengths.



@CBAMIN

Set the Minimum Length (Default: 2)



@CBAMAX

Set the Maximum Length (Default: 60)



If minimum length is set to be greater than maximum length, the scanner only decodes Codabar barcodes with either the minimum or maximum length. If minimum length is same as maximum length, only Codabar barcodes with that length are to be decoded.

E
sample

Set the scanner to decode Codabar barcodes containing between 8 and 12 characters:

1. Scan the **Enter Setup** barcode.
2. Scan the **Set the Minimum Length** barcode.
3. Scan the numeric barcode “8” from the “Digit Barcodes” section in Appendix.
4. Scan the **Save** barcode from the “Save/Cancel Barcodes” section in Appendix.
5. Scan the **Set the Maximum Length** barcode.
6. Scan the numeric barcodes “1” and “2” from the “Digit Barcodes” section in Appendix.
7. Scan the **Save** barcode from the “Save/Cancel Barcodes” section in Appendix.
8. Scan the **Exit Setup** barcode.



#SETUPE0
**** Exit Setup**



#SETUPE1

Enter Setup

Check Character Verification

A check character is optional for Codabar and can be added as the last character. It is a calculated value used to verify the integrity of the data.

- ◇ **Disable:** The scanner transmits Codabar barcodes as is.
- ◇ **Do Not Transmit Check Character After Verification:** The scanner checks the integrity of all Codabar barcodes to verify that the data complies with the check character algorithm. Barcodes passing the check will be transmitted except the last digit, whereas those failing it will not be transmitted.
- ◇ **Transmit Check Character After Verification:** The scanner checks the integrity of all Codabar barcodes to verify that the data complies with the check character algorithm. Barcodes passing the check will be transmitted, whereas those failing it will not be transmitted.

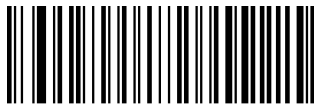

@CBACHK0

** Disable



@CBACHK1

Do Not Transmit Check Character After Verification

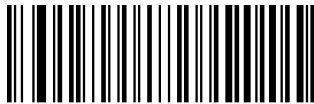

@CBACHK2

Transmit Check Character After Verification



If the **Do Not Transmit Check Character After Verification** option is enabled, Codabar barcodes with a length that is less than the configured minimum length after having the check character excluded will not be decoded. (For example, when the **Do Not Transmit Check Character After Verification** option is enabled and the minimum length is set to 4, Codabar barcodes with a total length of 4 characters including the check character cannot be read.)



#SETUPE0

** Exit Setup



#SETUPE1
Enter Setup

Start/Stop Character

You can set the start/stop characters and choose whether or not to transmit the start/stop characters by scanning the appropriate barcode below.



@CBATSC0

**** Do Not Transmit Start/Stop Character**



@CBATSC1

Transmit Start/Stop Character



@CBASCF0

**** ABCD/ABCD as the Start/Stop Character**



@CBASCF1

ABCD/TN*e as the Start/Stop Character



@CBASCF2

abcd/abcd as the Start/Stop Character



@CBASCF3

abcd/tn*e as the Start/Stop Character



#SETUPE0
**** Exit Setup**



#SETUPE1
Enter Setup

Code 93

Restore Factory Defaults



@C93DEF
Restore the Factory Defaults of Code 93

Enable/Disable Code 93



@C93ENA1
**** Enable Code 93**



@C93ENA0
Disable Code 93



If the scanner fails to identify Code 93 barcodes, you may first try this solution by scanning the **Enter Setup** barcode and then **Enable Code 93** barcode.

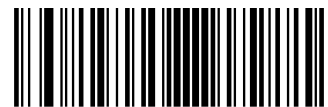

#SETUPE0
**** Exit Setup**



#SETUPE1
Enter Setup

Set Length Range for Code 93

The scanner can be configured to only decode Code 93 barcodes with lengths that fall between (inclusive) the minimum and maximum lengths. To accomplish it, you need to set the minimum and maximum lengths.



Set the Minimum Length (Default: 1)



Set the Maximum Length (Default: 48)



If minimum length is set to be greater than maximum length, the scanner only decodes Code 93 barcodes with either the minimum or maximum length. If minimum length is same as maximum length, only Code 93 barcodes with that length are to be decoded.

E*xample*

Set the scanner to decode Code 93 barcodes containing between 8 and 12 characters:

1. Scan the **Enter Setup** barcode.
2. Scan the **Set the Minimum Length** barcode.
3. Scan the numeric barcode “8” from the “Digit Barcodes” section in Appendix.
4. Scan the **Save** barcode from the “Save/Cancel Barcodes” section in Appendix.
5. Scan the **Set the Maximum Length** barcode.
6. Scan the numeric barcodes “1” and “2” from the “Digit Barcodes” section in Appendix.
7. Scan the **Save** barcode from the “Save/Cancel Barcodes” section in Appendix.
8. Scan the **Exit Setup** barcode.



#SETUPE0
**** Exit Setup**



#SETUPE1

Enter Setup

Check Character Verification

Check characters are optional for Code 93 and can be added as the last two characters, which are calculated values used to verify the integrity of the data.

- ◇ **Disable:** The scanner transmits Code 93 barcodes as is.
- ◇ **Do Not Transmit Check Character After Verification:** The scanner checks the integrity of all Code 93 barcodes to verify that the data complies with the check character algorithm. Barcodes passing the checks will be transmitted except the last two digits, whereas those failing them will not be transmitted.
- ◇ **Transmit Check Character After Verification:** The scanner checks the integrity of all Code 93 barcodes to verify that the data complies with the check character algorithm. Barcodes passing the checks will be transmitted, whereas those failing them will not be transmitted.



@C93CHK0

Disable



@C93CHK1

**** Do Not Transmit Check Character After Verification**



@C93CHK2

Transmit Check Character After Verification



If the **Do Not Transmit Check Character After Verification** option is enabled, Code 93 barcodes with a length that is less than the configured minimum length after having the two check characters excluded will not be decoded. (For example, when the **Do Not Transmit Check Character After Verification** option is enabled and the minimum length is set to 4, Code 93 barcodes with a total length of 4 characters including the two check characters cannot be read.)



#SETUPE0

**** Exit Setup**



#SETUPE1
Enter Setup

China Post 25

Restore Factory Defaults



@CHPDEF
Restore the Factory Defaults of China Post 25

Enable/Disable China Post 25



@CHPENA1
Enable China Post 25



@CHPENAO
**** Disable China Post 25**



If the scanner fails to identify China Post 25 barcodes, you may first try this solution by scanning the **Enter Setup** barcode and then **Enable China Post 25** barcode.



#SETUPE0
**** Exit Setup**



#SETUPE1

Enter Setup

Set Length Range for China Post 25

The scanner can be configured to only decode China Post 25 barcodes with lengths that fall between (inclusive) the minimum and maximum lengths. To accomplish it, you need to set the minimum and maximum lengths.



@CHPMIN

Set the Minimum Length (Default: 1)

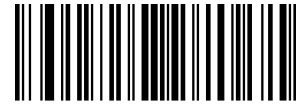

@CHPMAX

Set the Maximum Length (Default: 48)



If minimum length is set to be greater than maximum length, the scanner only decodes China Post 25 barcodes with either the minimum or maximum length. If minimum length is same as maximum length, only China Post 25 barcodes with that length are to be decoded.



Set the scanner to decode China Post 25 barcodes containing between 8 and 12 characters:

1. Scan the **Enter Setup** barcode.
2. Scan the **Set the Minimum Length** barcode.
3. Scan the numeric barcode “8” from the “Digit Barcodes” section in Appendix.
4. Scan the **Save** barcode from the “Save/Cancel Barcodes” section in Appendix.
5. Scan the **Set the Maximum Length** barcode.
6. Scan the numeric barcodes “1” and “2” from the “Digit Barcodes” section in Appendix.
7. Scan the **Save** barcode from the “Save/Cancel Barcodes” section in Appendix.
8. Scan the **Exit Setup** barcode.

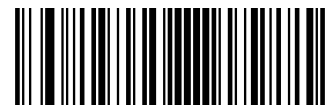

#SETUPE0

**** Exit Setup**



#SETUPE1
Enter Setup

Check Character Verification

A check character is optional for China Post 25 and can be added as the last character. It is a calculated value used to verify the integrity of the data.

- ◇ **Disable:** The scanner transmits China Post 25 barcodes as is.
- ◇ **Do Not Transmit Check Character After Verification:** The scanner checks the integrity of all China Post 25 barcodes to verify that the data complies with the check character algorithm. Barcodes passing the check will be transmitted except the last digit, whereas those failing it will not be transmitted.
- ◇ **Transmit Check Character After Verification:** The scanner checks the integrity of all China Post 25 barcodes to verify that the data complies with the check character algorithm. Barcodes passing the check will be transmitted, whereas those failing it will not be transmitted.



@CHPCHK0
** Disable



@CHPCHK1

Do Not Transmit Check Character After Verification



@CHPCHK2

Transmit Check Character After Verification



If the **Do Not Transmit Check Character After Verification** option is enabled, China Post 25 barcodes with a length that is less than the configured minimum length after having the check character excluded will not be decoded. (For example, when the **Do Not Transmit Check Character After Verification** option is enabled and the minimum length is set to 4, China Post 25 barcodes with a total length of 4 characters including the check character cannot be read.)



#SETUPE0
** Exit Setup



#SETUPE1
Enter Setup

GS1-128 (UCC/EAN-128)

Restore Factory Defaults



@GS1DEF

Restore the Factory Defaults of GS1-128

Enable/Disable GS1-128



@GS1ENA1

** Enable GS1-128



@GS1ENA0

Disable GS1-128



If the scanner fails to identify GS1-128 barcodes, you may first try this solution by scanning the **EnterSetup** barcode and then **Enable GS1-128** barcode.



#SETUPE0

** Exit Setup



#SETUPE1
Enter Setup

Set Length Range for GS1-128

The scanner can be configured to only decode GS1-128 barcodes with lengths that fall between (inclusive) the minimum and maximum lengths. To accomplish it, you need to set the minimum and maximum lengths.



@GS1MIN
Set the Minimum Length (Default: 1)



@GS1MAX
Set the Maximum Length (Default: 48)



If minimum length is set to be greater than maximum length, the scanner only decodes GS1-128 barcodes with either the minimum or maximum length. If minimum length is same as maximum length, only GS1-128 barcodes with that length are to be decoded.

Example

Set the scanner to decode GS1-128 barcodes containing between 8 and 12 characters:

1. Scan the **Enter Setup** barcode.
2. Scan the **Set the Minimum Length** barcode.
3. Scan the numeric barcode “8” from the “Digit Barcodes” section in Appendix.
4. Scan the **Save** barcode from the “Save/Cancel Barcodes” section in Appendix.
5. Scan the **Set the Maximum Length** barcode.
6. Scan the numeric barcodes “1” and “2” from the “Digit Barcodes” section in Appendix.
7. Scan the **Save** barcode from the “Save/Cancel Barcodes” section in Appendix.
8. Scan the **Exit Setup** barcode.



#SETUPE0
** Exit Setup



#SETUPE1
Enter Setup

GS1 Databar (RSS)

Restore Factory Defaults



@RSSDEF

Restore the Factory Defaults of GS1 Databar

Enable/Disable GS1 Databar



@RSSENA1

** Enable GS1 Databar



@RSSENA0

Disable GS1 Databar



If the scanner fails to identify GS1 Databar barcodes, you may first try this solution by scanning the **Enter Setup** barcode and then **Enable GS1 Databar** barcode.

Transmit Application Identifier "01"



@RSSTA1

** Transmit Application Identifier "01"



@RSSTA0

Do Not Transmit Application Identifier "01"



#SETUPE0

** Exit Setup



#SETUPE1
Enter Setup

GS1 Composite (EAN-UCC Composite)

Restore Factory Defaults



@CPTDEF
Restore the Factory Defaults of GS1 Composite

Enable/Disable GS1 Composite



@CPTENA1
Enable GS1 Composite



@CPTENA0
** Disable GS1 Composite



If the scanner fails to identify GS1 Composite barcodes, you may first try this solution by scanning the **Enter Setup** barcode and then **Enable GS1 Composite** barcode.

Enable/Disable UPC/EAN Composite

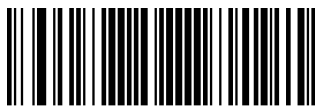

@CPTUPC1
Enable UPC/EAN Composite



@CPTUPC0
** Disable UPC/EAN Composite



#SETUPE0
** Exit Setup



#SETUPE1
Enter Setup

Code 11

Restore Factory Defaults



@C11DEF

Restore the Factory Defaults of Code 11

Enable/Disable Code 11



@C11ENA1

**** Enable Code 11**



@C11ENA0

Disable Code 11



If the scanner fails to identify Code 11 barcodes, you may first try this solution by scanning the **Enter Setup** barcode and then **Enable Code 11** barcode.



#SETUPE0
**** Exit Setup**



#SETUPE1
Enter Setup

Set Length Range for Code 11

The scanner can be configured to only decode Code 11 barcodes with lengths that fall between (inclusive) the minimum and maximum lengths. To accomplish it, you need to set the minimum and maximum lengths.



@C11MIN
Set the Minimum Length (Default: 4)



@C11MAX
Set the Maximum Length (Default: 48)



If minimum length is set to be greater than maximum length, the scanner only decodes Code 11 barcodes with either the minimum or maximum length. If minimum length is same as maximum length, only Code 11 barcodes with that length are to be decoded.



Set the scanner to decode Code 11 barcodes containing between 8 and 12 characters:

1. Scan the **Enter Setup** barcode.
2. Scan the **Set the Minimum Length** barcode.
3. Scan the numeric barcode “8” from the “Digit Barcodes” section in Appendix.
4. Scan the **Save** barcode from the “Save/Cancel Barcodes” section in Appendix.
5. Scan the **Set the Maximum Length** barcode.
6. Scan the numeric barcodes “1” and “2” from the “Digit Barcodes” section in Appendix.
7. Scan the **Save** barcode from the “Save/Cancel Barcodes” section in Appendix.
8. Scan the **Exit Setup** barcode.



#SETUPE0
**** Exit Setup**



#SETUPE1
Enter Setup

Check Character Verification

Check characters are optional for Code 11 and can be added as the last one or two characters, which are calculated values used to verify the integrity of the data.

If the **Disable** option is enabled, the scanner transmits Code 11 barcodes as is.



@C11CHK0
Disable



@C11CHK1
** One Check Character, MOD11



@C11CHK2
Two Check Characters, MOD11/MOD11



@C11CHK3
Two Check Characters, MOD11/MOD9



@C11CHK4
One Check Character, MOD11 (Len<=10)
Two Check Characters, MOD11/MOD11(Len>10)



@C11CHK5
One Check Character, MOD11 (Len<=10)
Two Check Characters, MOD11/MOD9 (Len>10)

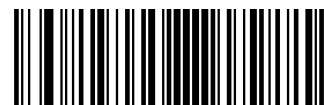

#SETUPE0
** Exit Setup



#SETUPE1
Enter Setup

Transmit Check Character



@C11TCK0
Do Not Transmit Code 11 Check Character



** Transmit Code 11 Check Character



If you select a check character algorithm and the **Do Not Transmit Check Character** option, Code 11 barcodes with a length that is less than the configured minimum length after having the check character(s) excluded will not be decoded. (For example, when the **One Check Character, MOD11** and **Do Not Transmit Check Character** options are enabled and the minimum length is set to 4, Code 11 barcodes with a total length of 4 characters including the check character cannot be read.)



#SETUPE0
** Exit Setup



#SETUPE1

Enter Setup

ISBN

Restore Factory Defaults



@ISBDEF

Restore the Factory Defaults of ISBN

Enable/Disable ISBN



@ISBENA1

****Enable ISBN**



@ISBENA0

Disable ISBN



If the scanner fails to identify ISBN barcodes, you may first try this solution by scanning the **Enter Setup** barcode and then **Enable ISBN** barcode.

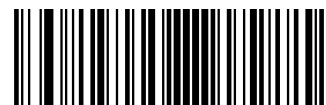

#SETUPE0

**** Exit Setup**



#SETUPE1
Enter Setup

Set ISBN Format



@ISBT101
**** ISBN-10**



@ISBT100
ISBN-13



#SETUPE0
**** Exit Setup**



#SETUPE1
Enter Setup

ISSN

Restore Factory Defaults



@ISSDEF
Restore the Factory Defaults of ISSN

Enable/Disable ISSN



@ISSENA1
Enable ISSN



@ISSENA0
**** Disable ISSN**



If the scanner fails to identify ISSN barcodes, you may first try this solution by scanning the **Enter Setup** barcode and then **Enable ISSN** barcode.

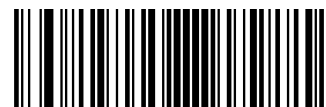

#SETUPE0
**** Exit Setup**



#SETUPE1
Enter Setup

Industrial 25

Restore Factory Defaults



@L25DEF
Restore the Factory Defaults of Industrial 25

Enable/Disable Industrial 25



@L25ENA1
**** Enable Industrial 25**



@L25ENA0
Disable Industrial 25



If the scanner fails to identify Industrial 25 barcodes, you may first try this solution by scanning the **Enter Setup** barcode and then **Enable Industrial 25** barcode.



#SETUPE0
**** Exit Setup**



#SETUPE1

Enter Setup

Set Length Range for Industrial 25

The scanner can be configured to only decode Industrial 25 barcodes with lengths that fall between (inclusive) the minimum and maximum lengths. To accomplish it, you need to set the minimum and maximum lengths.



@L25MIN

Set the Minimum Length (Default: 6)



@L25MAX

Set the Maximum Length (Default: 48)



If minimum length is set to be greater than maximum length, the scanner only decodes Industrial 25 barcodes with either the minimum or maximum length. If minimum length is same as maximum length, only Industrial 25 barcodes with that length are to be decoded.

E *sample*

Set the scanner to decode Industrial 25 barcodes containing between 8 and 12 characters:

1. Scan the **Enter Setup** barcode.
2. Scan the **Set the Minimum Length** barcode.
3. Scan the numeric barcode “8” from the “Digit Barcodes” section in Appendix.
4. Scan the **Save** barcode from the “Save/Cancel Barcodes” section in Appendix.
5. Scan the **Set the Maximum Length** barcode.
6. Scan the numeric barcodes “1” and “2” from the “Digit Barcodes” section in Appendix.
7. Scan the **Save** barcode from the “Save/Cancel Barcodes” section in Appendix.
8. Scan the **Exit Setup** barcode.



#SETUPE0

**** Exit Setup**



#SETUPE1
Enter Setup

Check Character Verification

A check character is optional for Industrial 25 and can be added as the last character. It is a calculated value used to verify the integrity of the data.

- ◇ **Disable:** The scanner transmits Industrial 25 barcodes as is.
- ◇ **Do Not Transmit Check Character After Verification:** The scanner checks the integrity of all Industrial 25 barcodes to verify that the data complies with the check character algorithm. Barcodes passing the check will be transmitted except the last digit, whereas those failing it will not be transmitted.
- ◇ **Transmit Check Character After Verification:** The scanner checks the integrity of all Industrial 25 barcodes to verify that the data complies with the check character algorithm. Barcodes passing the check will be transmitted, whereas those failing it will not be transmitted.

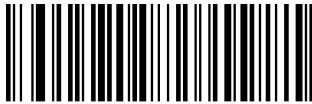

@L25CHK0
** Disable



Do Not Transmit Check Character After Verification



Transmit Check Character After Verification



If the **Do Not Transmit Check Character After Verification** option is enabled, Industrial 25 barcodes with a length that is less than the configured minimum length after having the check character excluded will not be decoded. (For example, when the **Do Not Transmit Check Character After Verification** option is enabled and the minimum length is set to 4, Industrial 25 barcodes with a total length of 4 characters including the check character cannot be read.)



#SETUPE0
** Exit Setup



#SETUPE1
Enter Setup

Standard 25

Restore Factory Defaults



@S25DEF
Restore the Factory Defaults of Standard 25

Enable/Disable Standard 25



@S25ENA1
**** Enable Standard 25**



@S25ENA0
Disable Standard 25



If the scanner fails to identify Standard 25 barcodes, you may first try this solution by scanning the **Enter Setup** barcode and then **Enable Standard 25** barcode.



#SETUPE0
**** Exit Setup**



#SETUPE1
Enter Setup

Set Length Range for Standard 25

The scanner can be configured to only decode Standard 25 barcodes with lengths that fall between (inclusive) the minimum and maximum lengths. To accomplish it, you need to set the minimum and maximum lengths.



@S25MIN
Set the Minimum Length (Default: 6)



@S25MAX
Set the Maximum Length (Default: 48)



If minimum length is set to be greater than maximum length, the scanner only decodes Standard 25 barcodes with either the minimum or maximum length. If minimum length is same as maximum length, only Standard 25 barcodes with that length are to be decoded.



Set the scanner to decode Standard 25 barcodes containing between 8 and 12 characters:

1. Scan the **Enter Setup** barcode.
2. Scan the **Set the Minimum Length** barcode.
3. Scan the numeric barcode “8” from the “Digit Barcodes” section in Appendix.
4. Scan the **Save** barcode from the “Save/Cancel Barcodes” section in Appendix.
5. Scan the **Set the Maximum Length** barcode.
6. Scan the numeric barcodes “1” and “2” from the “Digit Barcodes” section in Appendix.
7. Scan the **Save** barcode from the “Save/Cancel Barcodes” section in Appendix.
8. Scan the **Exit Setup** barcode.



#SETUPE0
** Exit Setup



#SETUPE1

Enter Setup

Check Character Verification

A check character is optional for Standard 25 and can be added as the last character. It is a calculated value used to verify the integrity of the data.

- ◇ **Disable:** The scanner transmits Standard 25 barcodes as is.
- ◇ **Do Not Transmit Check Character After Verification:** The scanner checks the integrity of all Standard 25 barcodes to verify that the data complies with the check character algorithm. Barcodes passing the check will be transmitted except the last digit, whereas those failing it will not be transmitted.
- ◇ **Transmit Check Character After Verification:** The scanner checks the integrity of all Standard 25 barcodes to verify that the data complies with the check character algorithm. Barcodes passing the check will be transmitted, whereas those failing it will not be transmitted.



@S25CHK0

** Disable



@S25CHK1

Do Not Transmit Check Character After Verification



@S25CHK2

Transmit Check Character After Verification



If the **Do Not Transmit Check Character After Verification** option is enabled, Standard 25 barcodes with a length that is less than the configured minimum length after having the check character excluded will not be decoded. (For example, when the **Do Not Transmit Check Character After Verification** option is enabled and the minimum length is set to 4, Standard 25 barcodes with a total length of 4 characters including the check character cannot be read.)

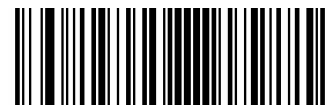

#SETUPE0

** Exit Setup



#SETUPE1
Enter Setup

Plessey

Restore Factory Defaults



@PLYDEF
Restore the Factory Defaults of Plessey

Enable/Disable Plessey



@PLYENA1
Enable Plessey

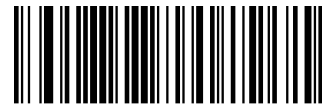

@PLYENA0
**** Disable Plessey**



If the scanner fails to identify Plessey barcodes, you may first try this solution by scanning the **Enter Setup** barcode and then **Enable Plessey** barcode.



#SETUPE0
**** Exit Setup**



#SETUPE1

Enter Setup

Set Length Range for Plessey

The scanner can be configured to only decode Plessey barcodes with lengths that fall between (inclusive) the minimum and maximum lengths. To accomplish it, you need to set the minimum and maximum lengths.



@PLYMIN

Set the Minimum Length (Default: 48)



@PLYMAX

Set the Maximum Length (Default: 4)



If minimum length is set to be greater than maximum length, the scanner only decodes Plessey barcodes with either the minimum or maximum length. If minimum length is same as maximum length, only Plessey barcodes with that length are to be decoded.

Set the scanner to decode Plessey barcodes containing between 8 and 12 characters:

E
xample

1. Scan the **Enter Setup** barcode.
2. Scan the **Set the Minimum Length** barcode.
3. Scan the numeric barcode “8” from the “Digit Barcodes” section in Appendix.
4. Scan the **Save** barcode from the “Save/Cancel Barcodes” section in Appendix.
5. Scan the **Set the Maximum Length** barcode.
6. Scan the numeric barcodes “1” and “2” from the “Digit Barcodes” section in Appendix.
7. Scan the **Save** barcode from the “Save/Cancel Barcodes” section in Appendix.
8. Scan the **Exit Setup** barcode.



#SETUPE0

** Exit Setup



#SETUPE1
Enter Setup

Check Character Verification

Check characters are optional for Plessey and can be added as the last two characters, which are calculated values used to verify the integrity of the data.

- ◇ **Disable:** The scanner transmits Plessey barcodes as is.
- ◇ **Do Not Transmit Check Character After Verification:** The scanner checks the integrity of all Plessey barcodes to verify that the data complies with the check character algorithm. Barcodes passing the checks will be transmitted except the last two digits, whereas those failing them will not be transmitted.
- ◇ **Transmit Check Character After Verification:** The scanner checks the integrity of all Plessey barcodes to verify that the data complies with the check character algorithm. Barcodes passing the checks will be transmitted, whereas those failing them will not be transmitted.



@PLYCHK0
** Disable

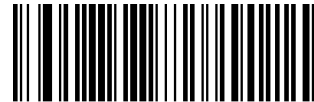

Do Not Transmit Check Character After Verification



Transmit Check Character After Verification



If the **Do Not Transmit Check Character After Verification** option is enabled, Plessey barcodes with a length that is less than the configured minimum length after having the check characters excluded will not be decoded. (For example, when the **Do Not Transmit Check Character After Verification** option is enabled and the minimum length is set to 4, Plessey barcodes with a total length of 4 characters including the check characters cannot be read.)



#SETUPE0
** Exit Setup



#SETUPE1
Enter Setup

MSI-Plessey

Restore Factory Defaults



@MSIDF

Restore the Factory Defaults of MSI-Plessey

Enable/Disable MSI-Plessey



@MSIENA1

Enable MSI-Plessey



@MSIENA0

**** Disable MSI-Plessey**



If the scanner fails to identify MSI-Plessey barcodes, you may first try this solution by scanning the **Enter Setup** barcode and then **Enable MSI-Plessey** barcode.



#SETUPE0
**** Exit Setup**



#SETUPE1
Enter Setup

Set Length Range for MSI-Plessey

The scanner can be configured to only decode MSI-Plessey barcodes with lengths that fall between (inclusive) the minimum and maximum lengths. To accomplish it, you need to set the minimum and maximum lengths.



Set the Minimum Length (Default: 4)



Set the Maximum Length (Default: 48)



If minimum length is set to be greater than maximum length, the scanner only decodes MSI-Plessey barcodes with either the minimum or maximum length. If minimum length is same as maximum length, only MSI-Plessey barcodes with that length are to be decoded.

E
sample

Set the scanner to decode MSI-Plessey barcodes containing between 8 and 12 characters:

1. Scan the **Enter Setup** barcode.
2. Scan the **Set the Minimum Length** barcode.
3. Scan the numeric barcode “8” from the “Digit Barcodes” section in Appendix.
4. Scan the **Save** barcode from the “Save/Cancel Barcodes” section in Appendix.
5. Scan the **Set the Maximum Length** barcode.
6. Scan the numeric barcodes “1” and “2” from the “Digit Barcodes” section in Appendix.
7. Scan the **Save** barcode from the “Save/Cancel Barcodes” section in Appendix.
8. Scan the **Exit Setup** barcode.



#SETUPE0
**** Exit Setup**



#SETUPE1

Enter Setup

Check Character Verification

Check characters are optional for MSI-Plessey and can be added as the last one or two characters, which are calculated values used to verify the integrity of the data.

If the **Disable** option is enabled, the scanner transmits MSI-Plessey barcodes as is.



@MSICLK0

Disable



@MSICLK1

**** One Check Character, MOD10**



@MSICLK2

Two Check Characters, MOD10/MOD10



@MSICLK3

Two Check Characters, MOD10/MOD11



#SETUPE0

**** Exit Setup**



#SETUPE1
Enter Setup

Transmit Check Character



@MSITCK1

** Transmit MSI-Plessey Check Character



@MSITCK0

Do Not Transmit MSI-Plessey Check Character



If you select a check character algorithm and the **Do Not Transmit Check Character** option, MSI-Plessey barcodes with a length that is less than the configured minimum length after having the check character(s) excluded will not be decoded. (For example, when the **One Check Character, MOD10** and **Do Not Transmit Check Character** options are enabled and the minimum length is set to 4, MSI-Plessey barcodes with a total length of 4 characters including the check character cannot be read.)



#SETUPE0
** Exit Setup



#SETUPE1
Enter Setup

AIM 128

Restore Factory Defaults



@AIMDEF
Restore the Factory Defaults of AIM 128

Enable/Disable AIM 128



@AIMENA1
**** Enable AIM 128**



@AIMENA0
Disable AIM 128



If the scanner fails to identify AIM 128 barcodes, you may first try this solution by scanning the **Enter Setup** barcode and then **Enable AIM 128** barcode.



#SETUPE0
**** Exit Setup**



#SETUPE1
Enter Setup

Set Length Range for AIM 128

The scanner can be configured to only decode AIM 128 barcodes with lengths that fall between (inclusive) the minimum and maximum lengths. To accomplish it, you need to set the minimum and maximum lengths.



@AIMMIN
Set the Minimum Length (Default: 1)



@AIMMAX
Set the Maximum Length (Default: 48)



If minimum length is set to be greater than maximum length, the scanner only decodes AIM 128 barcodes with either the minimum or maximum length. If minimum length is same as maximum length, only AIM 128 barcodes with that length are to be decoded.



Set the scanner to decode AIM 128 barcodes containing between 8 and 12 characters:

1. Scan the **Enter Setup** barcode.
2. Scan the **Set the Minimum Length** barcode.
3. Scan the numeric barcode “8” from the “Digit Barcodes” section in Appendix.
4. Scan the **Save** barcode from the “Save/Cancel Barcodes” section in Appendix.
5. Scan the **Set the Maximum Length** barcode.
6. Scan the numeric barcodes “1” and “2” from the “Digit Barcodes” section in Appendix.
7. Scan the **Save** barcode from the “Save/Cancel Barcodes” section in Appendix.
8. Scan the **Exit Setup** barcode.



#SETUPE0
**** Exit Setup**



#SETUPE1
Enter Setup

ISBT 128

Restore Factory Defaults



@IBTDEF
Restore the Factory Defaults of ISBT 128

Enable/Disable ISBT 128



@IBTENA1
Enable ISBT 128



@IBTENA0
**** Disable ISBT 128**



If the scanner fails to identify ISBT 128 barcodes, you may first try this solution by scanning the **Enter Setup** barcode and then **Enable ISBT 128** barcode.



#SETUPE0
**** Exit Setup**



#SETUPE1
Enter Setup

Code 49

Restore Factory Defaults



@C49DEF

Restore the Factory Defaults of AIM 49

Enable/Disable AIM 49



@C49ENA1

** Enable AIM 49



@C49ENA0

Disable AIM 49



If the scanner fails to identify Code 49 barcodes, you may first try this solution by scanning the **Enter Setup** barcode and then **Enable AIM 49** barcode.



#SETUPE0
** Exit Setup



#SETUPE1

Enter Setup

Set Length Range for Code 49

The scanner can be configured to only decode Code 49 barcodes with lengths that fall between (inclusive) the minimum and maximum lengths. To accomplish it, you need to set the minimum and maximum lengths.



@C49MIN

Set the Minimum Length (Default: 1)



@C49MAX

Set the Maximum Length (Default: 80)



If minimum length is set to be greater than maximum length, the scanner only decodes Code 49 barcodes with either the minimum or maximum length. If minimum length is same as maximum length, only Code 49 barcodes with that length are to be decoded.



Set the scanner to decode Code 49 barcodes containing between 8 and 12 characters:

1. Scan the **Enter Setup** barcode.
2. Scan the **Set the Minimum Length** barcode.
3. Scan the numeric barcode “8” from the “Digit Barcodes” section in Appendix.
4. Scan the **Save** barcode from the “Save/Cancel Barcodes” section in Appendix.
5. Scan the **Set the Maximum Length** barcode.
6. Scan the numeric barcodes “1” and “2” from the “Digit Barcodes” section in Appendix.
7. Scan the **Save** barcode from the “Save/Cancel Barcodes” section in Appendix.
8. Scan the **Exit Setup** barcode.



#SETUPE0

**** Exit Setup**



#SETUPE1
Enter Setup

Code 16K

Restore Factory Defaults



@16KDEF
Restore the Factory Defaults of Code 16K

Enable/Disable AIM 49

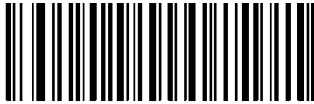

@16KENA1
** Enable Code 16K



@16KENA0
Disable Code 16K



If the scanner fails to identify Code 16K barcodes, you may first try this solution by scanning the **Enter Setup** barcode and then **Enable Code 16K** barcode.



#SETUPE0
** Exit Setup



#SETUPE1

Enter Setup

Set Length Range for Code 16K

The scanner can be configured to only decode Code 16K barcodes with lengths that fall between (inclusive) the minimum and maximum lengths. To accomplish it, you need to set the minimum and maximum lengths.



@16KMIN

Set the Minimum Length (Default: 1)



@16KMAX

Set the Maximum Length (Default: 80)



If minimum length is set to be greater than maximum length, the scanner only decodes Code 16K barcodes with either the minimum or maximum length. If minimum length is same as maximum length, only Code 16K barcodes with that length are to be decoded.

E
example

Set the scanner to decode Code 16K barcodes containing between 8 and 12 characters:

1. Scan the **Enter Setup** barcode.
2. Scan the **Set the Minimum Length** barcode.
3. Scan the numeric barcode “8” from the “Digit Barcodes” section in Appendix.
4. Scan the **Save** barcode from the “Save/Cancel Barcodes” section in Appendix.
5. Scan the **Set the Maximum Length** barcode.
6. Scan the numeric barcodes “1” and “2” from the “Digit Barcodes” section in Appendix.
7. Scan the **Save** barcode from the “Save/Cancel Barcodes” section in Appendix.
8. Scan the **Exit Setup** barcode.



#SETUPE0

**** Exit Setup**



#SETUPE1
Enter Setup

PDF417

Restore Factory Defaults



@PDFDEF
Restore the Factory Defaults of PDF417

Enable/Disable PDF417



@PDFENA1
**** Enable PDF417**



@PDFENA0
Disable PDF417



If the scanner fails to identify PDF417 barcodes, you may first try this solution by scanning the **Enter Setup** barcode and then **Enable PDF417** barcode.



#SETUPE0
**** Exit Setup**



#SETUPE1

Enter Setup

Set Length Range for PDF417

The scanner can be configured to only decode PDF417 barcodes with lengths that fall between (inclusive) the minimum and maximum lengths. To accomplish it, you need to set the minimum and maximum lengths.



@PDFMIN

Set the Minimum Length (Default: 1)



@PDFMAX

Set the Maximum Length (Default: 2710)



Minimum length is not allowed to be greater than maximum length. If you only want to read PDF417 barcodes with a specific length, set both minimum and maximum lengths to be that desired length.

Set the scanner to decode PDF417 barcodes containing between 8 and 12 characters:

E
xample

1. Scan the **Enter Setup** barcode.
2. Scan the **Set the Minimum Length** barcode.
3. Scan the numeric barcode “8” from the “Digit Barcodes” section in Appendix.
4. Scan the **Save** barcode from the “Save/Cancel Barcodes” section in Appendix.
5. Scan the **Set the Maximum Length** barcode.
6. Scan the numeric barcodes “1” and “2” from the “Digit Barcodes” section in Appendix.
7. Scan the **Save** barcode from the “Save/Cancel Barcodes” section in Appendix.
8. Scan the **Exit Setup** barcode.



#SETUPE0

**** Exit Setup**



#SETUPE1
Enter Setup

PDF417 Twin Code

PDF417 twin code is 2 PDF417 barcodes paralleled vertically or horizontally. They must both be either regular or inverse barcodes. They must have similar specifications and be placed closely together.

There are 3 options for reading PDF417 twin codes:

- ◇ **Single PDF417 Only:** Read either PDF417 code.
- ◇ **Twin PDF417 Only:** Read both PDF417 codes.
- ◇ **Both Single & Twin:** Read both PDF417 codes. If successful, transmit as twin PDF417 only. Otherwise, try single PDF417 only.



@PDFDOU0
**** Single PDF417 Only**



@PDFDOU1
Twin PDF417 Only



@PDFDOU2
Both Single & Twin



#SETUPE0
**** Exit Setup**



#SETUPE1
Enter Setup

PDF417 Inverse

Regular barcode: Dark bars on a bright background.

Inverse barcode: Bright bars on a dark background.



@PDFINV0

**** Decode Regular PDF417 Barcodes Only**



@PDFINV1

Decode Inverse PDF417 Barcodes Only



@PDFINV2

Decode Both

Character Encoding



@PDFENC0

**** Default Character Encoding**



@PDFENC1

UTF-8



@PDFENC2

Automatically select UTF-8 or Code Page



#SETUPE0

**** Exit Setup**



#SETUPE1
Enter Setup

PDF417 ECI Output



@PDFECI0
Disable PDF417 ECI Output



@PDFECI1
**** Enable PDF417 ECI Output**



#SETUPE0
**** Exit Setup**



#SETUPE1
Enter Setup

Micro PDF417

Restore Factory Defaults



@MPDDEF

Restore the Factory Defaults of Micro PDF417

Enable/Disable Micro PDF417



@MPDENA1

Enable Micro PDF417



@MPDENA0

** Disable Micro PDF417



If the scanner fails to identify Micro PDF417 barcodes, you may first try this solution by scanning the **Enter Setup** barcode and then **Enable Micro PDF417** barcode.



#SETUPE0
** Exit Setup



#SETUPE1
Enter Setup

Set Length Range for Micro PDF417

The scanner can be configured to only decode Micro PDF417 barcodes with lengths that fall between (inclusive) the minimum and maximum lengths. To accomplish it, you need to set the minimum and maximum lengths.



Set the Minimum Length (Default: 1)



Set the Maximum Length (Default: 366)



Minimum length is not allowed to be greater than maximum length. If you only want to read Micro PDF417 barcodes with a specific length, set both minimum and maximum lengths to be that desired length.

E *xample*

Set the scanner to decode Micro PDF417 barcodes containing between 8 and 12 characters:

1. Scan the **Enter Setup** barcode.
2. Scan the **Set the Minimum Length** barcode.
3. Scan the numeric barcode “8” from the “Digit Barcodes” section in Appendix.
4. Scan the **Save** barcode from the “Save/Cancel Barcodes” section in Appendix.
5. Scan the **Set the Maximum Length** barcode.
6. Scan the numeric barcodes “1” and “2” from the “Digit Barcodes” section in Appendix.
7. Scan the **Save** barcode from the “Save/Cancel Barcodes” section in Appendix.
8. Scan the **Exit Setup** barcode.



#SETUPE0
**** Exit Setup**



#SETUPE1
Enter Setup

QR Code

Restore Factory Defaults



@QRCDEF
Restore the Factory Defaults of QR Code

Enable/Disable QR Code



@QRCENA1
** Enable QR Code



@QRCENA0
Disable QR Code



If the scanner fails to identify QR Code barcodes, you may first try this solution by scanning the **Enter Setup** barcode and then **Enable QR Code** barcode.



#SETUPE1
Enter Setup



#SETUPE1
Enter Setup

Set Length Range for QR Code

The scanner can be configured to only decode QR Code barcodes with lengths that fall between (inclusive) the minimum and maximum lengths. To accomplish it, you need to set the minimum and maximum lengths.



@QRCMIN
Set the Minimum Length (Default: 1)



@QRMAX
Set the Maximum Length (Default: 7089)



Minimum length is not allowed to be greater than maximum length. If you only want to read QR Code barcodes with a specific length, set both minimum and maximum lengths to be that desired length.

Example

Set the scanner to decode QR Code barcodes containing between 8 and 12 characters:

1. Scan the **Enter Setup** barcode.
2. Scan the **Set the Minimum Length** barcode.
3. Scan the numeric barcode “8” from the “Digit Barcodes” section in Appendix.
4. Scan the **Save** barcode from the “Save/Cancel Barcodes” section in Appendix.
5. Scan the **Set the Maximum Length** barcode.
6. Scan the numeric barcodes “1” and “2” from the “Digit Barcodes” section in Appendix.
7. Scan the **Save** barcode from the “Save/Cancel Barcodes” section in Appendix.
8. Scan the **Exit Setup** barcode.

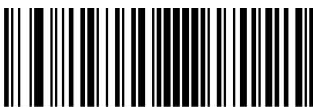

#SETUPE1
Enter Setup



#SETUPE1

Enter Setup

QR Twin Code

QR twin code is 2 QR barcodes paralleled vertically or horizontally. They must both be either regular or inverse barcodes. They must have similar specifications and be placed closely together.

There are 3 options for reading QR twin codes:

- ◇ **Single QR Only:** Read either QR code.
- ◇ **Twin QR Only:** Read both QR codes. Transmission sequence: left (upper) QR code followed by right (lower) QR code.
- ◇ **Both Single & Twin:** Read both QR codes. If successful, transmit as twin QR only. Otherwise, try single QR only.



@QRCDU0

** Single QR Only



@QRCDU1

Twin QR Only



@QRCDU2

Both Single & Twin



#SETUPE1

Enter Setup



#SETUPE1
Enter Setup

QR Inverse

Regular barcode: Dark bars on a bright background.

Inverse barcode: Bright bars on a dark background.



@QRCINV0

**** Decode Regular QR Barcodes Only**



@QRCINV1

Decode Inverse QR Barcodes Only

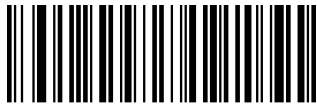

@QRCINV2

Decode Both

Character Encoding

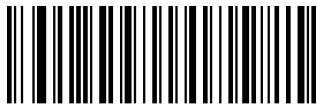

@QRCENC0

**** Default Character Encoding**



@QRCENC1

UTF-8



@QRCENC3

Automatically select UTF-8 or Code Page



#SETUPE1
Enter Setup



#SETUPE1
Enter Setup

QR ECI Output



@QRCEC10
Disable QR ECI Output



@QRCEC11
** Enable QR ECI Output

Website QR Code

Website QR is the QR code starts with “http” or “HTTP”

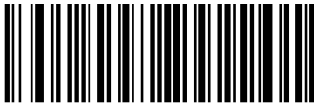

@QRCURL0
Disable



@QRCURL1
**Enable



#SETUPE1
Enter Setup



#SETUPE1
Enter Setup

Micro QR Code

Restore Factory Defaults



@MQRDEF
Restore the Factory Defaults of Micro QR

Enable/Disable Micro QR



@MQRENA1
**** Enable Micro QR**



@MQRENA0
Disable Micro QR



If the scanner fails to identify Micro QR barcodes, you may first try this solution by scanning the **Enter Setup** barcode and then **Enable Micro QR** barcode.

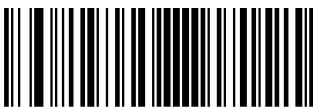

#SETUPE1
Enter Setup



#SETUPE1

Enter Setup

Set Length Range for Micro QR

The scanner can be configured to only decode Micro QR barcodes with lengths that fall between (inclusive) the minimum and maximum lengths. To accomplish it, you need to set the minimum and maximum lengths.



@MQRMIN

Set the Minimum Length (Default: 1)



@MQRMAX

Set the Maximum Length (Default: 35)



Minimum length is not allowed to be greater than maximum length. If you only want to read Micro QR barcodes with a specific length, set both minimum and maximum lengths to be that desired length.

E
sample

Set the scanner to decode Micro QR Code barcodes containing between 8 and 12 characters:

1. Scan the **Enter Setup** barcode.
2. Scan the **Set the Minimum Length** barcode.
3. Scan the numeric barcode “8” from the “Digit Barcodes” section in Appendix.
4. Scan the **Save** barcode from the “Save/Cancel Barcodes” section in Appendix.
5. Scan the **Set the Maximum Length** barcode.
6. Scan the numeric barcodes “1” and “2” from the “Digit Barcodes” section in Appendix.
7. Scan the **Save** barcode from the “Save/Cancel Barcodes” section in Appendix.
8. Scan the **Exit Setup** barcode.



#SETUPE1

Enter Setup



#SETUPE1
Enter Setup

Aztec

Restore Factory Defaults



@AZTDEF
Restore the Factory Defaults of Aztec Code

Enable/Disable Aztec Code



@AZTENA1
Enable Aztec Code



@AZTENA0
**** Disable Aztec Code**



If the scanner fails to identify Aztec Code barcodes, you may first try this solution by scanning the **Enter Setup** barcode and then **Enable Aztec Code** barcode.

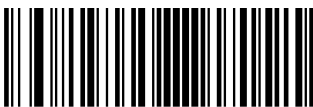

#SETUPE1
Enter Setup



#SETUPE1

Enter Setup

Set Length Range for Aztec Code

The scanner can be configured to only decode Aztec barcodes with lengths that fall between (inclusive) the minimum and maximum lengths. To accomplish it, you need to set the minimum and maximum lengths.



@AZTMIN

Set the Minimum Length (Default: 1)



@AZTMAX

Set the Maximum Length (Default: 3832)



Minimum length is not allowed to be greater than maximum length. If you only want to read Aztec barcodes with a specific length, set both minimum and maximum lengths to be that desired length.

E
xample

Set the scanner to decode Aztec barcodes containing between 8 and 12 characters:

1. Scan the **Enter Setup** barcode.
2. Scan the **Set the Minimum Length** barcode.
3. Scan the numeric barcode “8” from the “Digit Barcodes” section in Appendix.
4. Scan the **Save** barcode from the “Save/Cancel Barcodes” section in Appendix.
5. Scan the **Set the Maximum Length** barcode.
6. Scan the numeric barcodes “1” and “2” from the “Digit Barcodes” section in Appendix.
7. Scan the **Save** barcode from the “Save/Cancel Barcodes” section in Appendix.
8. Scan the **Exit Setup** barcode.



#SETUPE1

Enter Setup



#SETUPE1
Enter Setup

Read Multi-barcodes on an Image

There are three options:

- ◇ **Mode 1:** Read one barcode only.
- ◇ **Mode 2:** Read fixed number of barcodes only.
- ◇ **Mode 3:** Composite Reading. Read fixed number of barcodes first. If unsuccessful, read one barcode only.



@AZTMOD1
**** Mode 1**



@AZTMOD2
Mode 2



@AZTMOD3
Mode 3

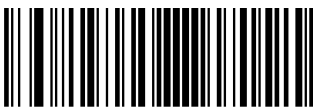

#SETUPE1
Enter Setup



#SETUPE1
Enter Setup

Set the Number of Barcodes



@AZTMUL1
** 1



@AZTMUL3
3

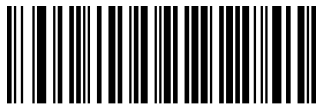

@AZTMUL5
5



@AZTMUL7
7



@AZTMUL2
2



@AZTMUL4
4



@AZTMUL6
6



@AZTMUL8
8



#SETUPE1
Enter Setup



#SETUPE1
Enter Setup

Aztec Inverse

Regular barcode: Dark bars on a bright background. Inverse barcode: Bright bars on a dark background.



@AZTINV0

**** Decode Regular Aztec Barcodes Only**



@AZTINV1

Decode Inverse Aztec Barcodes Only



@AZTINV2

Decode Both

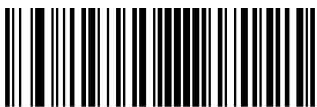

#SETUPE1
Enter Setup



#SETUPE1
Enter Setup

Character Encoding



@AZTENC0
**** Default Character Encoding**



@AZTENC1
UTF-8



@AZTENC2
Automatically select UTF-8 or Code Page

Aztec ECI Output



@AZTECI0
Disable Aztec ECI Output



@AZTECI1
**** Enable Aztec ECI Output**



#SETUPE1
Enter Setup



#SETUPE1
Enter Setup

Data Matrix

Restore Factory Defaults



@DMCDEF
Restore the Factory Defaults of Data Matrix

Enable/Disable Data Matrix



@DMCENA1
**** Enable Data Matrix**



@DMCENA0
Disable Data Matrix



If the scanner fails to identify Data Matrix barcodes, you may first try this solution by scanning the **Enter Setup** barcode and then **Enable Data Matrix** barcode.

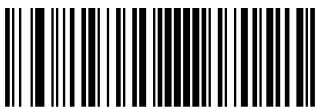

#SETUPE1
Enter Setup



#SETUPE1

Enter Setup

Set Length Range for Data Matrix

The scanner can be configured to only decode Data Matrix barcodes with lengths that fall between (inclusive) the minimum and maximum lengths. To accomplish it, you need to set the minimum and maximum lengths.



@DMCMIN

Set the Minimum Length (Default: 1)

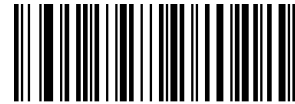

@DMCMAX

Set the Maximum Length (Default: 3116)



Minimum length is not allowed to be greater than maximum length. If you only want to read Data Matrix barcodes with a specific length, set both minimum and maximum lengths to be that desired length.

Example

Set the scanner to decode Data Matrix barcodes containing between 8 and 12 characters:

1. Scan the **Enter Setup** barcode.
2. Scan the **Set the Minimum Length** barcode.
3. Scan the numeric barcode “8” from the “Digit Barcodes” section in Appendix.
4. Scan the **Save** barcode from the “Save/Cancel Barcodes” section in Appendix.
5. Scan the **Set the Maximum Length** barcode.
6. Scan the numeric barcodes “1” and “2” from the “Digit Barcodes” section in Appendix.
7. Scan the **Save** barcode from the “Save/Cancel Barcodes” section in Appendix.
8. Scan the **Exit Setup** barcode.

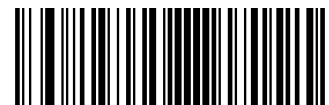

#SETUPE1

Enter Setup



#SETUPE1
Enter Setup

Data Matrix Twin Code

Data Matrix twin code is 2 Data Matrix barcodes paralleled vertically or horizontally. They must both be either regular or inverse barcodes. They must have similar specifications and be placed closely together.

There are 3 options for reading Data Matrix twin codes:

- ◇ **Single Data Matrix Only:** Read either Data Matrix code.
- ◇ **Twin Data Matrix Only:** Read both Data Matrix codes. Transmission sequence: left (upper) Data Matrix code followed by right (lower) Data Matrix code.
- ◇ **Both Single & Twin:** Read both Data Matrix codes. If successful, transmit as twin Data Matrix only. Otherwise, try single Data Matrix only.



@DMCDOU0
**** Single Data Matrix Only**



@DMCDOU1
Twin Data Matrix Only



@DMCDOU2
Both Single & Twin

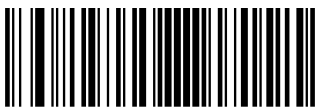

#SETUPE1
Enter Setup



#SETUPE1

Enter Setup

Rectangular Barcode

Data Matrix has two formats:

Square barcodes having the same amount of modules in length and width: 10*10, 12*12.... 144*144.

Rectangular barcodes having different amounts of models in length and width: 6*16, 6*14...14*22.



@DMCREC1

**** Enable Rectangular Barcode**



@DMCREC0

Disable Rectangular Barcode

Data Matrix Inverse

Regular barcode: Dark bars on a bright background.

Inverse barcode: Bright bars on a dark background.

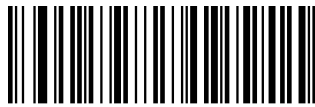

@DMCINV0

**** Decode Regular Data Matrix Barcodes Only**



@DMCINV1

Decode Inverse Data Matrix Barcodes Only

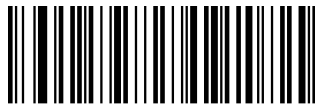

@DMCINV2

Decode Both

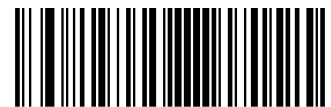

#SETUPE1

Enter Setup



#SETUPE1
Enter Setup

Character Encoding



@DMCENC0
** Default Character Encoding



@DMCENC1
UTF-8

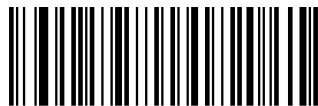

@DMCENC2
Automatically select UTF-8 or Code Page

Data Matrix ECI Output



@DMCEC10
Disable Data Matrix ECI Output



@DMCEC11
** Enable Data Matrix ECI Output

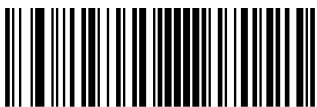

#SETUPE1
Enter Setup



#SETUPE1
Enter Setup

Maxicode

Restore Factory Defaults



@MXCDEF

Restore the Factory Defaults of Maxicode

Enable/Disable Maxicode



@MXCENA1

Enable Maxicode



@MXCENA0

** Disable Maxicode



If the scanner fails to identify Maxicode barcodes, you may first try this solution by scanning the **Enter Setup** barcode and then **Enable Maxicode** barcode.

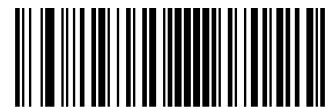

#SETUPE1
Enter Setup



#SETUPE1
Enter Setup

Set Length Range for Maxicode

The scanner can be configured to only decode Maxicode barcodes with lengths that fall between (inclusive) the minimum and maximum lengths. To accomplish it, you need to set the minimum and maximum lengths.



@MXCMIN
Set the Minimum Length (Default: 1)



@MXCMAX
Set the Maximum Length (Default:150)



Minimum length is not allowed to be greater than maximum length. If you only want to read Maxicode barcodes with a specific length, set both minimum and maximum lengths to be that desired length.

E *sample*

Set the scanner to decode Maxicode barcodes containing between 8 and 12 characters:

1. Scan the **Enter Setup** barcode.
2. Scan the **Set the Minimum Length** barcode.
3. Scan the numeric barcode “8” from the “Digit Barcodes” section in Appendix.
4. Scan the **Save** barcode from the “Save/Cancel Barcodes” section in Appendix.
5. Scan the **Set the Maximum Length** barcode.
6. Scan the numeric barcodes “1” and “2” from the “Digit Barcodes” section in Appendix.
7. Scan the **Save** barcode from the “Save/Cancel Barcodes” section in Appendix.
8. Scan the **Exit Setup** barcode.

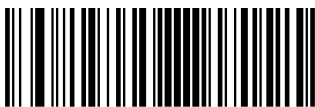

#SETUPE1
Enter Setup



#SETUPE1
Enter Setup

Chinese Sensible Code

Restore Factory Defaults



@CSCDEF

Restore the Factory Defaults of Chinese Sensible Code

Enable/Disable Chinese Sensible Code



@CSCENA1

Enable Chinese Sensible Code



@CSCENA0

**** Disable Chinese Sensible Code**



If the scanner fails to identify Chinese Sensible Code barcodes, you may first try this solution by scanning the **Enter Setup** barcode and then **Enable Chinese Sensible Code** barcode.



#SETUPE1
Enter Setup



#SETUPE1
Enter Setup

Set Length Range for Chinese Sensible Code

The scanner can be configured to only decode Chinese Sensible Code barcodes with lengths that fall between (inclusive) the minimum and maximum lengths. To accomplish it, you need to set the minimum and maximum lengths.



@CSCMIN
Set the Minimum Length (Default: 1)



@CSCMAX
Set the Maximum Length (Default: 7827)



Minimum length is not allowed to be greater than maximum length. If you only want to read Chinese Sensible Code barcodes with a specific length, set both minimum and maximum lengths to be that desired length.

Example

Set the scanner to decode Chinese Sensible Code barcodes containing between 8 and 12 characters:

1. Scan the **Enter Setup** barcode.
2. Scan the **Set the Minimum Length** barcode.
3. Scan the numeric barcode “8” from the “Digit Barcodes” section in Appendix.
4. Scan the **Save** barcode from the “Save/Cancel Barcodes” section in Appendix.
5. Scan the **Set the Maximum Length** barcode.
6. Scan the numeric barcodes “1” and “2” from the “Digit Barcodes” section in Appendix.
7. Scan the **Save** barcode from the “Save/Cancel Barcodes” section in Appendix.
8. Scan the **Exit Setup** barcode.



#SETUPE1
Enter Setup



#SETUPE1

Enter Setup

Chinese Sensible Twin Code

Chinese Sensible twin code is 2 Chinese Sensible barcodes paralleled vertically or horizontally. They must both be either regular or inverse barcodes. They must have similar specifications and be placed closely together.

There are 3 options for reading Chinese Sensible twin codes:

- ◇ **Single Chinese Sensible Code Only:** Read either Chinese Sensible code.
- ◇ **Twin Chinese Sensible Code Only:** Read both Chinese Sensible codes. Transmission sequence: left (upper) Chinese Sensible code followed by right (lower) Chinese Sensible code.
- ◇ **Both Single & Twin:** Read both Chinese Sensible codes. If successful, transmit as twin Chinese Sensible Code only. Otherwise, try single Chinese Sensible Code only.



@CSCDOU0

**** Single Chinese Sensible Code Only**



@CSCDOU1

Twin Chinese Sensible Code Only



@CSCDOU2

Both Single & Twin



#SETUPE1

Enter Setup



#SETUPE1
Enter Setup

Chinese Sensible Code Inverse

Regular barcode: Dark bars on a bright background.

Inverse barcode: Bright bars on a dark background.



@CSCINV0

**** Decode Regular Chinese Sensible Barcodes Only**

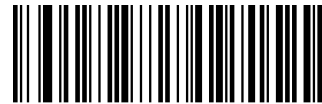

@CSCINV1

Decode Inverse Chinese Sensible Barcodes Only



@CSCINV2

Decode Both

ECI Output



@CSCEC0

Disable ECI Output



@CSCEC1

**** Enable ECI Output**



#SETUPE1
Enter Setup



#SETUPE1
Enter Setup

GM Code Restore Factory Defaults



@GMCDEF
Restore the Factory Defaults of GM

Enable/Disable GM



@GMCENA1
Enable GM



@GMCENA0
**** Disable GM**



If the scanner fails to identify GM barcodes, you may first try this solution by scanning the **Enter Setup** barcode and then **Enable GM** barcode.

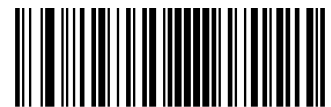

#SETUPE1
Enter Setup



#SETUPE1
Enter Setup

Set Length Range for GM

The scanner can be configured to only decode GM barcodes with lengths that fall between (inclusive) the minimum and maximum lengths. To accomplish it, you need to set the minimum and maximum lengths.



@GMCMIN
Set the Minimum Length (Default: 1)



@GMC MAX
Set the Maximum Length (Default: 2751)



Minimum length is not allowed to be greater than maximum length. If you only want to read GM barcodes with a specific length, set both minimum and maximum lengths to be that desired length.



Set the scanner to decode GM barcodes containing between 8 and 12 characters:

1. Scan the **Enter Setup** barcode.
2. Scan the **Set the Minimum Length** barcode.
3. Scan the numeric barcode “8” from the “Digit Barcodes” section in Appendix.
4. Scan the **Save** barcode from the “Save/Cancel Barcodes” section in Appendix.
5. Scan the **Set the Maximum Length** barcode.
6. Scan the numeric barcodes “1” and “2” from the “Digit Barcodes” section in Appendix.
7. Scan the **Save** barcode from the “Save/Cancel Barcodes” section in Appendix.
8. Scan the **Exit Setup** barcode.



#SETUPE1
Enter Setup



#SETUPE1
Enter Setup

Code One Restore Factory Defaults



@ONEDEF
Restore the Factory Defaults of Code One

Enable/Disable Code One



@ONEENA1
Enable Code One

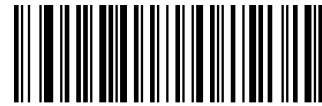

@ONEENA0
** Disable Code One



If the scanner fails to identify Code One barcodes, you may first try this solution by scanning the **Enter Setup** barcode and then **Enable Code One** barcode.

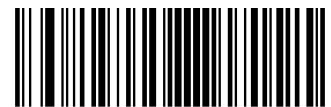

#SETUPE1
Enter Setup



#SETUPE1
Enter Setup

Set Length Range for Code One

The scanner can be configured to only decode Code One barcodes with lengths that fall between (inclusive) the minimum and maximum lengths. To accomplish it, you need to set the minimum and maximum lengths.



Set the Minimum Length (Default: 1)



Set the Maximum Length (Default: 3550)



Minimum length is not allowed to be greater than maximum length. If you only want to read Code One barcodes with a specific length, set both minimum and maximum lengths to be that desired length.



Set the scanner to decode Code One barcodes containing between 8 and 12 characters:

1. Scan the **Enter Setup** barcode.
2. Scan the **Set the Minimum Length** barcode.
3. Scan the numeric barcode “8” from the “Digit Barcodes” section in Appendix.
4. Scan the **Save** barcode from the “Save/Cancel Barcodes” section in Appendix.
5. Scan the **Set the Maximum Length** barcode.
6. Scan the numeric barcodes “1” and “2” from the “Digit Barcodes” section in Appendix.
7. Scan the **Save** barcode from the “Save/Cancel Barcodes” section in Appendix.
8. Scan the **Exit Setup** barcode.



#SETUPE1
Enter Setup



#SETUPE1
Enter Setup

DotCode Restore Factory Defaults



@DOTDEF
Restore the Factory Defaults of DotCode

Enable/Disable DotCode



@DOTENA1
Enable DotCode



@DOTENA0
** Disable DotCode



If the scanner fails to identify DotCode barcodes, you may first try this solution by scanning the **Enter Setup** barcode and then **Enable DotCode** barcode.



#SETUPE1
Enter Setup



#SETUPE1
Enter Setup

USPS Postnet Restore Factory Defaults



@PNTDEF
Restore the Factory Defaults of USPS Postnet

Enable/Disable USPS Postnet



@PNTENA1
Enable USPS Postnet



@PNTENA0
**** Disable USPS Postnet**



If the scanner fails to identify USPS Postnet barcodes, you may first try this solution by scanning the **Enter Setup** barcode and then **Enable USPS Postnet** barcode.

Transmit Check Character



@PNTCHK1
Do Not Transmit USPS Postnet Check Character



@PNTCHK2
**** Transmit USPS Postnet Check Character**



#SETUPE1
Enter Setup



#SETUPE1
Enter Setup

USPS Intelligent Mail Restore Factory Defaults



@ILGDEF
Restore the Factory Defaults of USPS Intelligent Mail

Enable/Disable USPS Intelligent Mail



@ILGENA1
Enable USPS Intelligent Mail



@ILGENA0
** Disable USPS Intelligent Mail



If the scanner fails to identify USPS Intelligent Mail barcodes, you may first try this solution by scanning the **Enter Setup** barcode and then **Enable USPS Intelligent Mail** barcode.



#SETUPE1
Enter Setup



#SETUPE1
Enter Setup

Royal Mail Restore Factory Defaults



@ROYDEF
Restore the Factory Defaults of Royal Mail

Enable/Disable Royal Mail



@ROYENA1
Enable Royal Mail

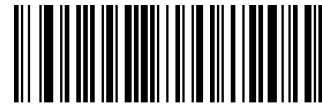

@ROYENA0
**** Disable Royal Mail**



If the scanner fails to identify Royal Mail barcodes, you may first try this solution by scanning the **Enter Setup** barcode and then **Enable Royal Mail** barcode.



#SETUPE1
Enter Setup



#SETUPE1
Enter Setup

USPS Planet Restore Factory Defaults



@PLADEF
Restore the Factory Defaults of USPS Planet

Enable/Disable USPS Planet



@PLAENA1
Enable USPS Planet



@PLAENA0
** Disable USPS Planet



If the scanner fails to identify USPS Planet barcodes, you may first try this solution by scanning the **Enter Setup** barcode and then **Enable USPS Planet** barcode.

Transmit Check Character



@PLACHK1
Do Not Transmit USPS Planet Check Character

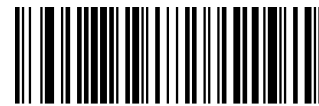

@PLACHK2
** Transmit USPS Planet Check Character



@SETUPE0
** Exit Setup



#SETUPE1
Enter Setup

KIX Post Restore Factory Defaults



@KIXDEF
Restore the Factory Defaults of KIX Post

Enable/Disable KIX Post



@KIXENA1
Enable KIX Post



@KIXENA0
**** Disable KIX Post**



If the scanner fails to identify KIX Post barcodes, you may first try this solution by scanning the **Enter Setup** barcode and then **Enable KIX Post** barcode.



@SETUPE0
**** Exit Setup**



#SETUPE1
Enter Setup

Australian Postal Restore Factory Defaults



@APLDEF

Restore the Factory Defaults of Australian Postal

Enable/Disable Australian Postal



@APLENA1

Enable Australian Postal



@APLENA0

**** Disable Australian Postal**



If the scanner fails to identify Australian Postal barcodes, you may first try this solution by scanning the **Enter Setup** barcode and then **Enable Australian Postal** barcode.



@SETUPE0

**** Exit Setup**



#SETUPE1
Enter Setup

Japan Post Restore Factory Defaults



@JPPDEF
Restore the Factory Defaults of Japan Post

Enable/Disable Specific Japan Post



@JPPENA1
Enable Japan Post



@JPPENA0
**** Disable Japan Post**



If the scanner fails to identify Specific Japan Post barcodes, you may first try this solution by scanning the **Enter Setup** barcode and then **Enable Japan Post** barcode.

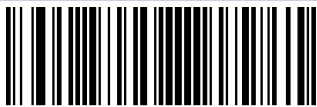

@SETUPE0
**** Exit Setup**



#SETUPE1
Enter Setup

Passport OCR

Restore Factory Defaults



@PASDEF
Restore the Factory Defaults of Passport OCR

Enable/Disable Passport OCR



@PASENA1
Enable Passport OCR



@PASENA0
**** Disable Passport OCR**



If the scanner fails to identify Passport OCR barcodes, you may first try this solution by scanning the **Enter Setup** barcode and then **Enable Passport OCR** barcode.



@SETUPE0
**** Exit Setup**



#SETUPE1
Enter Setup

Chinese ID Card OCR Restore Factory Defaults



@IDCDEF
** Restore the Factory Defaults of Chinese ID Card OCR

Enable/Disable Chinese ID Card OCR

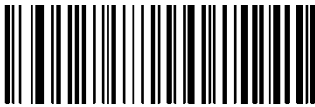

@IDCENA1
Enable Chinese ID Card OCR



@IDCENA0
** Disable Chinese ID Card OCR

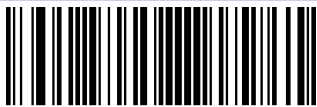

@SETUPE0
** Exit Setup



#SETUPE1
Enter Setup

China Travel Permit OCR Restore Factory Defaults



@CTPDEF
** Restore the Factory Defaults of China Travel
Permit OCR

Enable/Disable Chinese Travel Permit OCR



@CTPENA1
Enable Chinese Travel Permit OCR



@CTPENA0
** Disable Chinese Travel Permit OCR



@SETUPE0
** Exit Setup



#SETUPE1
Enter Setup

Chapter 6 Prefix&Suffix

Introduction

A 1D barcode could contain digits, letters, symbols, etc. A 2D barcode could contain more data, such as Chinese characters and other multi-byte characters. However, in real applications, they do not and should not have all information we need, such as barcode type, data acquisition time and delimiter, in order to keep the barcodes short and flexible.

Prefix and suffix are how to fulfill the needs mentioned above. They can be added, removed and modified while the original barcode data remains intact.



Barcode processing procedure:

1. Edit data with Data Formatter
2. Append prefix/suffix
3. Pack data
4. Append terminating character



#SETUPE1
Enter Setup



#SETUPE1
Enter Setup

Global Settings

Enable/Disable All Prefixes/Suffixes

Disable All Prefixes/Suffixes: Transmit barcode data with no prefix/suffix.

Enable All Prefixes/Suffixes: Allow to append Code ID prefix, AIM ID prefix, custom prefix/suffix and terminating character to the barcode data before the transmission.



@APSENA0
Disable All Prefixes/Suffixes



@APSENA1
Enable All Prefixes/Suffixes

Prefix Sequence



@PRESEQ0
**** Code ID+ Custom +AIM ID**



@PRESEQ1
Custom + Code ID + AIM ID

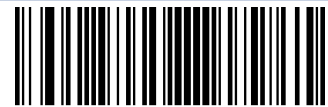

@SETUPE0
**** Exit Setup**



#SETUPE1
Enter Setup

Custom Prefix

Enable/Disable Custom Prefix

If custom prefix is enabled, you are allowed to append to the data a user-defined prefix that cannot exceed 10 characters. For example, if the custom prefix is “AB” and the barcode data is “123”, the Host will receive “AB123”.



@CPRENA0
** Disable Custom Prefix



@CPRENA1
Enable Custom Prefix

Set Custom Prefix

To set a custom prefix, scan the **Set Custom Prefix** barcode then the numeric barcodes corresponding to the hexadecimal value of a desired prefix then the **Save** barcode.

Note: A custom prefix cannot exceed 10 characters.



@CPRSET
Set Custom Prefix

Set the custom prefix to “CODE” (HEX: 0x43/0x4F/0x44/0x45):

E
xample

1. Scan the **Enter Setup** barcode.
2. Scan the **Set Custom Prefix** barcode.
3. Scan the numeric barcodes “4”, “3”, “4”, “F”, “4”, “4”, “4” and “5” from the “Digit Barcodes” section in Appendix.
4. Scan the **Save** barcode from the “Save/Cancel Barcodes” section in Appendix.
5. Scan the **Enable Custom Prefix** barcode.
6. Scan the **Exit Setup** barcode.



#SETUPE1
Enter Setup



#SETUPE1

Enter Setup

AIM ID Prefix

AIM (Automatic Identification Manufacturers) ID defines symbology identifier (For the details, see the “AIM ID Table” section in Appendix). If AIM ID prefix is enabled, the scanner will add the symbology identifier before the scanned data after decoding.



@AIDENA0

**** Disable AIM ID Prefix**



@AIDENA1

Enable AIM ID Prefix



AIM ID is not user programmable.



#SETUPE1

Enter Setup



#SETUPE1
Enter Setup

Code ID Prefix

Code ID can also be used to identify barcode type. Unlike AIM ID, Code ID is user programmable. Code ID can only consist of one or two English letters.



@CIDENA0
**** Disable Code ID Prefix**



@CIDENA1
Enable Code ID Prefix

Restore All Default Code IDs

For the information of default Code IDs, see the “Code ID Table” section in Appendix.



@CIDDEF
Restore All Default Code IDs

Modify Code ID

See the examples below to learn how to modify a Code ID and restore the default Code IDs of all symbologies.



#SETUPE1
Enter Setup



#SETUPE1
Enter Setup

E *sample*

Modify PDF417 Code ID to be “p” (HEX: 0x70):

1. Scan the **Enter Setup** barcode.
2. Scan the **Modify PDF417 Code ID** barcode.
3. Scan the numeric barcodes “7” and “0” from the “Digit Barcodes” section in Appendix.
4. Scan the **Save** barcode from the “Save/Cancel Barcodes” section in Appendix.
5. Scan the **Exit Setup** barcode.

Restore the default Code IDs of all symbologies:

1. Scan the **Enter Setup** barcode.
2. Scan the **Restore All Default Code IDs** barcode.
3. Scan the **Exit Setup** barcode.



#SETUPE1
Enter Setup



#SETUPE1
Enter Setup

1D symbologies:



@CID002
Modify Code 128 Code ID



@CID004
Modify EAN-8 Code ID



@CID006
Modify UPC-E Code ID



@CID008
Modify Interleaved 2 of 5 Code ID



@CID003
Modify GS1-128 Code ID



@CID005
Modify EAN-13 Code ID



@CID007
Modify UPC-A Code ID



#SETUPE1
Enter Setup



#SETUPE1
Enter Setup



@CID009
Modify ITF-14 Code ID



@CID010
Modify ITF-6 Code ID



@CID011
Modify Matrix 2 of 5 Code ID



@CID013
Modify Code 39 Code ID



@CID015
Modify Codabar Code ID



@CID017
Modify Code 93 Code ID



@CID019
Modify China Post 25 Code ID



@CID020
Modify AIM 128 Code ID



#SETUPE1
Enter Setup



#SETUPE1
Enter Setup



@CID023
Modify ISSN Code ID



@CID025
Modify Industrial 25 Code ID



@CID027
Modify Plessey Code ID



@CID029
Modify MSI-Plessey Code ID



@CID021
Modify ISBT 128 Code ID



@CID024
Modify ISBN Code ID



@CID026
Modify Standard 25 Code ID



@CID028
Modify Code 11 Code ID



#SETUPE1
Enter Setup



#SETUPE1
Enter Setup



@CID030
Modify GS1 Composite Code ID



@CID031
Modify GS1 Databar Code ID



@CID132
Modify Code 49 Code ID



@CID133
Modify Code 16K Code ID

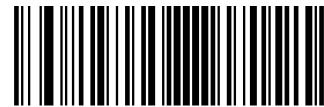

#SETUPE1
Enter Setup



#SETUPE1
Enter Setup

2D symbologies:



@CID032
Modify PDF417 Code ID



@CID034
Modify Aztec Code ID



@CID036
Modify Maxicode Code ID



@CID041
Modify GM Code ID



@CID033
Modify QR Code ID



@CID035
Modify Data Matrix Code ID



@CID039
Modify Chinese Sensible Code ID



#SETUPE1
Enter Setup



#SETUPE1
Enter Setup



@CID042
Modify Micro PDF417 Code ID



@CID043
Modify Micro QR Code ID

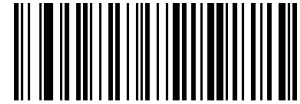

@CID048
Modify Code One Code ID



#SETUPE1
Enter Setup



#SETUPE1
Enter Setup

Postal symbologies:



@CID096

Modify USPS Postnet Code ID



@CID097

Modify USPS Intelligent Mail Code ID



@CID098

Modify Royal Mail Code ID

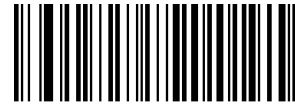

@CID099

Modify USPS Planet Code ID



@CID100

Modify KIX Post Code ID



@CID101

Modify Australian Postal Code ID



#SETUPE1
Enter Setup



#SETUPE1
Enter Setup

Custom Suffix

Enable/Disable Custom Suffix

If custom suffix is enabled, you are allowed to append to the data a user-defined suffix that cannot exceed 10 characters. For example, if the custom suffix is “AB” and the barcode data is “123”, the Host will receive “123AB”.



@CSUENA0
** Disable Custom Suffix

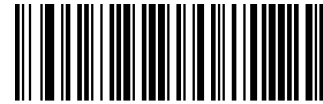

@CSUENA1
Enable Custom Suffix

Set Custom Suffix

To set a custom suffix, scan the **Set Custom Suffix** barcode then the numeric barcodes corresponding to the hexadecimal value of a desired suffix then the **Save** barcode.

Note: A custom suffix cannot exceed 10 characters.



@CSUSET
Set Custom Suffix

E
sample

Set the custom suffix to “CODE” (HEX: 0x43/0x4F/0x44/0x45):

1. Scan the **Enter Setup** barcode.
2. Scan the **Set Custom Suffix** barcode.
3. Scan the numeric barcodes “4”, “3”, “4”, “F”, “4”, “4”, “4” and “5” from the “Digit Barcodes” section in Appendix.
4. Scan the **Save** barcode from the “Save/Cancel Barcodes” section in Appendix.
5. Scan the **Enable Custom Suffix** barcode.
6. Scan the **Exit Setup** barcode.



#SETUPE1
Enter Setup



#SETUPE1

Enter Setup

Data Packing

Introduction

Data packing is designed for a specific group of users who want to have the data packed before transmission. Data packing influences data format, so it is advised to disable this feature when it is not required.

Data Packing Options

Disable Data Packing: Transmit decoded data in raw format (unpacked).

Enable Data Packing, Format 1: Transmit decoded data with the packet format 1 defined below.

Packet format 1: [STX + ATTR + LEN] + [AL_TYPE + DATA] + [LRC]

STX: 0x02

ATTR: 0x00

LEN: Barcode data length is expressed in 2 bytes ranging from 0x0000 (0) to 0xFFFF (65535).

AL_TYPE: 0x36

DATA: Raw barcode data.

LRC: Check digit.

LRC calculation algorithm: computation sequence: 0xFF+LEN+AL_TYPE+DATA; computation method is XOR, byte by byte.

Enable Data Packing, Format 2: Transmit decoded data with the packet format 2 defined below.

Packet format 2: [STX + ATTR + LEN] + [AL_TYPE] + [Symbology_ID + DATA] + [LRC]

STX: 0x02

ATTR: 0x00

LEN: Barcode data length is expressed in 2 bytes ranging from 0x0000 (0) to 0xFFFF (65535).

AL_TYPE: 0x3B

Symbology_ID: The ID number of symbology, 1 byte.

DATA: Raw barcode data.

LRC: Check digit.

LRC calculation algorithm: computation sequence: 0xFF+LEN+AL_TYPE+Symbology_ID+DATA; computation method is XOR, byte by byte.



#SETUPE1

Enter Setup



#SETUPE1
Enter Setup



@PACKAG0
**** Disable Data Packing**



@PACKAG1
Enable Data Packing, Format 1



@PACKAG2
Enable Data Packing, Format 2



#SETUPE1
Enter Setup

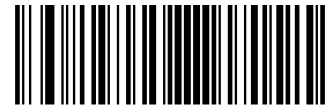

#SETUPE1

Enter Setup

Terminating Character Suffix

Enable/Disable Terminating Character Suffix

A terminating character such as carriage return (CR) or carriage return/line feed pair (CRLF) can only be used to mark the end of data, which means nothing can be added after it.



@TSUENA0

Disable Terminating Character Suffix



@TSUENA1

**** Enable Terminating Character Suffix**

Set Terminating Character Suffix

To set a terminating character suffix, scan the **Set Terminating Character Suffix** barcode then the numeric barcodes corresponding to the hexadecimal value of a desired terminating character then the **Save** barcode.

Note: A terminating character suffix cannot exceed 2 characters.



@TSUSET

Set Terminating Character Suffix



@TSUSET0D

**** Set Terminating Character to CR (0x0D)**



@TSUSET0D0A

Set Terminating Character to CRLF (0x0D,0x0A)



#SETUPE1

Enter Setup



#SETUPE1
Enter Setup

E *sample*

Set the terminating character suffix to 0x0A:

1. Scan the **Enter Setup** barcode.
2. Scan the **Set Terminating Character Suffix** barcode.
3. Scan the numeric barcodes "0" and "A" from the "Digit Barcodes" section in Appendix.
4. Scan the **Save** barcode from the "Save/Cancel Barcodes" section in Appendix.
5. Scan the **Enable Terminating Character Suffix** barcode.
6. Scan the **Exit Setup** barcode.



#SETUPE1
Enter Setup

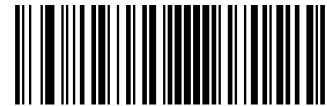

#SETUPE1

Enter Setup

Chapter 7 Batch Programming

Introduction

Batch programming enables users to integrate a batch of commands into a single batch barcode.

Listed below are batch programming rules:

1. Command format: Command + Parameter Value.
2. Each command is terminated by a semicolon (;). Note that there is no space between a command and its terminator semicolon.
3. Use the barcode generator software to generate a 2D batch barcode.

Example: Create a batch barcode for **Normal Illumination, Sense Mode, Decode Session Timeout = 2s, Disable Interleaved 2 of 5:**

1. Input the commands:

```
@ILLSCN1;SCNMOD2;ORTSET2000;I25ENA0;
```

2. Generate a batch barcode.

When setting up a scanner with the above configuration, scan the **Enable Batch Barcode** barcode and then the batch barcode generated.



@BATCHS

Enable Batch Barcode



#SETUPE1

Enter Setup



#SETUPE1

Enter Setup

Create a Batch Command

A batch command may contain a number of individual commands each of which is terminated by a semicolon (;). For more information, refer to the “Use of Programming Command” section in Chapter 3.

Create a Batch Barcode

Batch barcodes can be produced in the format of PDF417, QR Code or Data Matrix.

Example: Create a batch barcode for **Normal Illumination, Sense Mode, Decode Session Timeout = 2s, Disable Interleaved 2 of 5:**

1. Input the following commands:

```
@ILLSCN1;SCNMOD2;ORTSET2000;I25E
```

```
NA0;
```

2. Generate a PDF417 batch barcode.



@SETUPE0

** Exit Setup

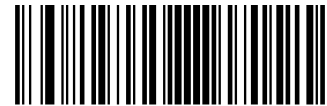

#SETUPE1
Enter Setup

Use Batch Barcode

To put a batch barcode into use, scan the following barcodes. (Use the example above.)



@SETUPE1
Enter Setup



@BATCHS
Enable Batch Barcode



Batch Barcode



@SETUPE0
Exit Setup



#SETUPE1
Enter Setup

Appendix

Digit Barcodes

0~9





@DIGIT6

6



@DIGIT7

7



@DIGIT8

8



@DIGIT9

9

A~F



Save/Cancel Barcodes

After reading numeric barcode(s), you need to scan the **Save** barcode to save the data. If you scan the wrong digit(s), you can either scan the **Cancel** barcode and then start the configuration all over again, or scan the **Delete the Last Digit** barcode and then the correct digit, or scan the **Delete All Digits** barcode and then the digits you want.

For instance, after reading the **Maximum Length** barcode and numeric barcodes “1”, “2” and “3”, you scan:

- ❖ **Delete the Last Digit:** The last digit “3” will be removed.
- ❖ **Delete All Digits:** All digits “123” will be removed.
- ❖ **Cancel:** The maximum length configuration will be cancelled. And the scanner is still in the setup mode.



Factory Defaults Table

Parameters	Factory Default	Remark
System Settings		
Hardware Settings		
Good Read LED	On	
Good Read LED Duration	Medium (120ms)	1-2,000ms
Illumination	On	
Aiming	On	
Good Read Vibration	On	
Good Read Vibration Duration	100	1-2,000ms
Image Flipping	Do Not Flip	
Beep		
Power On Beep	On	
Good Read Beep	On	
Good Read Beep Volume	High(20)	1-20
Good Read Beep Duration	Medium (80ms)	20-300ms
Good Read Beep Frequency	Medium (2730Hz)	
Scan Settings		
Barcode Programming	Disabled (Exit Setup)	
Programming Barcode Data	Do not transmit	
Scan Mode	Level Mode	
Smart Stand Mode	Enabled	
Trigger Commands	Disabled	
Image Stabilization Timeout (Sense Mode)	200ms	0-3,000ms
Decode Session Timeout	3,000ms.	0-3,600,000ms
Reread Timeout	Disabled	
	1500ms	1-3600000ms
Reset Reread Timeout	Off	
Image Decoding Timeout	500ms	1-3,000ms
Sensitivity	Enhanced Sensitivity (5)	1-20
Scanning Preference	Normal	
Read Barcode	On	
Image Luminance Limit	Disabled	
Custom Image Luminance	80	1-255
Exposure parameter Limit	Enabled	
Minimum Exposure Time	50 μ s	50-14,000 μ s
Maximum Exposure Time	2000 μ s	50-14,000 μ s
Gain Parameter Limit	Disabled	
Maximum Gain	49	1-64
Minimum Gain	1	1-64
Decode Area	Whole Area Decoding	

Transmit Bad Read Message	Disabled	
Modified Bad Read Message	NG	
Transmit Delay per Character for Febraban	Disabled	
Custom Transmit Delay per Character for Febraban	70ms	
Transmit Delay per 12 Characters for Febraban	Disabled	
Custom Transmit Delay per 12 Characters for Febraban	500ms	
USB Data Transmission Failure Notification	Disabled	
Transmit GS1 Check Character	Enabled	
GS1-128(UCC/EAN-13)	Transmit GS1 Check Character	
GS1 Databar(RSS)	Transmit GS1 Check Character	
GS1 QR	Transmit GS1 Check Character	
GS1 Data Matrix	Transmit GS1 Check Character	
Interface		
Interface	Bluetooth Dongle KBW	
Keyboard		
USB Country Keyboard	US keyboard	USB HID Keyboard
Emulate ALT+Keypad	Off	USB HID Keyboard
Control Characters Output	Disabled	USB HID Keyboard
Inter-Keystroke Delay	No Delay	USB HID Keyboard
Caps Lock	Off(Non Japanese Keypad)	USB HID Keyboard
Convert Case	No Case Conversion	USB HID Keyboard
Emulate Numeric Keypad 1	Off	USB HID Keyboard
Emulate Numeric Keypad 2	Off	USB HID Keyboard
Fast Mode	Off	USB HID Keyboard
Polling Rate	4ms	USB HID Keyboard
Unicode Encoding	Off	USB HID Keyboard
Beep on Unknown Character	Off	USB HID Keyboard
Emulate Keypad with Leading Zero	On	USB HID Keyboard
Code Page	Code Page 1252 (Latin, Western European)	USB HID Keyboard
Symbologies		
1D Barcode		
1D Twin Code	Single 1D Code Only	

Parentheses Surround GS1 Application Identifiers	Disabled	
Output GS1 Application Identifiers	Disabled	
Code 11		
Code 11	Enabled	
Maximum Length	127	
Minimum Length	1	
Check Character Verification	One Check Character, MOD11	
Check Character	Transmit	
Code 128		
Code 128	Enabled	
Maximum Length	127	
Minimum Length	1	
Code 39		
Code 39	Enabled	
Maximum Length	127	
Minimum Length	1	
Check Character Verification	Disabled	
Start/Stop Character	Do not transmit	
Code 39 Full ASCII	Disabled	
Code 32 Pharmaceutical (PARAF)	Disabled	
Code 32 Prefix	Disabled	
Code 32 Start/Stop Character	Do not transmit	
Code 32 Check Character	Do not transmit	
GS1-128(UCC/EAN-128)		
UCC/EAN-128	Enabled	
Maximum Length	127	
Minimum Length	1	
AIM 128		
AIM 128	Enabled	
Maximum Length	127	
Minimum Length	1	
ISBT 128		
ISBT 128	Disabled	
Codabar		
Codabar	Enabled	
Maximum Length	127	
Minimum Length	1	
Check Character Verification	Disabled	
Start/Stop Character	Do not transmit	
	ABCD/ABCD	All capital

Code 93		
Code 93	Enabled	
Maximum Length	127	
Minimum Length	1	
UPC-A		
UPC-A	Enabled	
Check Character	Transmit	
2-Digit Add-On Code	Disabled	
5-Digit Add-On Code	Disabled	
Add-On Code Required	Not Required	
Transmit Preamble Character	System Character	
UPC-E		
UPC-E	Enabled	
UPC-E0	Enabled	
UPC-E1	Disabled	
Check Character	Transmit	
2-Digit Add-On Code	Disabled	
5-Digit Add-On Code	Disabled	
Add-On Code Required	Not Required	
Transmit Preamble Character	System Character	
Convert UPC-E to UPC-A	Disable UPC-E Extend	
Coupon		
UPC-A/EAN-13 with Extended Coupon Code	Off	
Coupon GS1 DataBar Output	Off	
GS1 Composite		
GS1 Composite	Disabled	
UPC/EAN Composite	Disabled	
EAN-13		
EAN-13	Enabled	
Check Character	Transmit	
2-Digit Add-On Code	Disabled	
5-Digit Add-On Code	Disabled	
Add-On Code Required	Disabled	
EAN-13 Beginning with 290 Add-On Code Required	Do Not Require Add-On Code	
EAN-13 Beginning with 378/379 Add-On Code Required	Do Not Require Add-On Code	
EAN-13 Beginning with 414/419 Add-On Code Required	Do Not Require Add-On Code	
EAN-13 Beginning with 434/439 Add-On Code Required	Do Not Require Add-On Code	
EAN-13 Beginning with 977 Add-On Code		

Required	Do Not Require Add-On Code	
EAN-13 Beginning with 978 Add-On Code Required	Do Not Require Add-On Code	
EAN-13 Beginning with 979 Add-On Code Required	Do Not Require Add-On Code	
Japanese Magazine Code	Disabled	
EAN-8		
EAN-8	Enabled	
Check Character	Transmit	
2-Digit Add-On Code	Disabled	
5-Digit Add-On Code	Disabled	
Add-On Code Required	Not Required	
ISBN		
ISBN	Disabled	
Set ISBN Format	ISBN-10	
2-Digit Add-On Code	Disabled	
5-Digit Add-On Code	Disabled	
Add-On Code Required	Not Required	
Japanese Book Code	Disabled	
Japanese Book Code Separator	Disable Japanese Book Code Separator	
ISSN		
ISSN	Disabled	
2-Digit Add-On Code	Disabled	
5-Digit Add-On Code	Disabled	
Add-On Code Required	Not Required	
Interleaved 2 of 5		
Interleaved 2 of 5	Enabled	
Maximum Length	127	
Minimum Length	1	
Check Character Verification	Enable, But Do Not Transmit Check Character	
Febraban	Febraban Disabled	
Safety Level	Safety Level of Interleaved 2 of 5 is one.	
Matrix 2 of 5		
Matrix 2 of 5	Disabled	
Maximum Length	127	
Minimum Length	1	
Check Character Verification	Enable, But Do Not Transmit Check Character	
Industrial 25		
Industrial 25	Disabled	

Maximum Length	127	
Minimum Length	1	
Check Character Verification	Disabled	
ITF-14		
ITF-14	Disabled	
ITF-6		
ITF-6	Disabled	
Standard 25		
Standard 25	Disabled	
Maximum Length	127	
Minimum Length	1	
Check Character Verification	Do Not Transmit Check Character After Verification	
China Post 25		
China Post 25	Disabled	
Maximum Length	127	
Minimum Length	1	
Check Character Verification	Disabled	
Deutsche 14		
Deutsche 14	Disabled	
Deutsche 12		
Deutsche 12	Disabled	
MSI-Plessey		
MSI-Plessey	Disabled	
Maximum Length	127	
Minimum Length	1	
Check Character Verification	One Check Character, MOD10	
Check Character	Enabled	
Plessey		
Plessey	Disabled	
Maximum Length	127	
Minimum Length	1	
Check Character Verification	Disabled	
GS1 Databar		
GS1 Databar	Enabled	
Application Identifier "01"	Transmit	
Code 49		
Code 49	Disabled	
Maximum Length	127	
Minimum Length	1	
Code 16K		
Code 16K	Disabled	
Maximum Length	127	
Minimum Length	1	

2D Barcode		
PDF417		
PDF417	Enabled	
Maximum Length	2710	
Minimum Length	1	
PDF417 Twin Code	Single PDF417 Only	
PDF417 Inverse	Decode Regular PDF417 Barcodes Only	
Character Encoding	Default Character Encoding	
PDF417 ECI Output	Enabled	
QR Code		
QR Code	Enabled	
Maximum Length	7089	
Minimum Length	1	
QR Twin Code	Single QR Only	
QR Inverse	Decode Regular QR Barcodes Only	
Character Encoding	Default Character Encoding	
QR ECI Output	Enabled	
URL QR Code	Enabled	
Aztec Code		
Aztec Code	Disabled	
Maximum Length	3832	
Minimum Length	1	
Set the Number of Barcodes	1	
Read Multi-barcodes on an Image	Mode 1	
Character Encoding	Default Character Encoding	
Aztec ECI Output	Disabled	
Data Matrix		
Data Matrix	Enabled	
Maximum Length	3116	
Minimum Length	1	
Data Matrix Twin Code	Single Data Matrix Only	
Rectangular Barcode	Enabled	
Data Matrix Inverse	Decode Regular Data Matrix Barcodes Only	
Character Encoding	Default Character Encoding	
Data Matrix ECI Output	Enabled	
Maxi Code		
Maxi Code	Disabled	
Maximum Length	150	
Minimum Length	1	
Chinese Sensible Code		
Chinese Sensible Code	Disabled	

Maximum Length	7827	
Minimum Length	1	
Chinese Sensible Code Twin Code	Single Chinese Sensible Code Only	
Chinese Sensible Code Inverse	Decode Regular Chinese Sensible Bar Codes Only	
GM Code		
GM Code	Disabled	
Maximum Length	2751	
Minimum Length	1	
Micro PDF417		
Micro PDF417	Disabled	
Maximum Length	366	
Minimum Length	1	
Micro QR Code		
Micro QR Code	Enabled	
Maximum Length	35	
Minimum Length	1	
Code One		
Code One	Disabled	
Maximum Length	3550	
Minimum Length	1	
Dot Code		
Dot Code	Disabled	
Maximum Length	7089	
Minimum Length	1	
Dot Code Inverse	Dot Code Both	
OCR		
Passport OCR		
Passport OCR	Disabled	
Chinese ID Card		
Chinese ID Card	Disabled	
China Travel Permit OCR		
China Travel Permit OCR	Disabled	
Postal		
USPS Postnet		
USPS Postnet	Disabled	
Transmit Check Character	Transmit	
USPS Intelligent Mail		
USPS Intelligent Mail	Disabled	
Royal Mail		
Royal Mail	Disabled	
USPS Planet		
USPS Planet	Disabled	

Transmit Check Character	Transmit	
KIX Post		
KIX Post	Disabled	
Australian Postal		
Australian Postal	Disabled	
Japan Post		
Japan Post	Disabled	
Code ID Prefix	Disabled	
Prefix & Suffix		
Prefix Sequence	Code ID+ Custom +AIM ID	
Custom Prefix	Disabled	
AIM ID Prefix	Disabled	
Custom Suffix	Disabled	
Terminating Character Suffix	Enabled	
Modify Terminating Character Suffix	0D	
Data Formatter		
Data Format	Disabled Data Format	
Change Data Format	Data Format 0	
Non-Match Error Beep	Enabled	
Data Packing	Disabled	
Driver License Decoding		
Advanced Formatting/Label Editing Scripts	Disabled	
Extract Elements	Disabled	
Wireless Communications		
Operating Mode	Bluetooth Dongle KBW	
Batch Mode Option	Off	
Prevent Same Barcode Storage	Off	
Batch Mode Transmit Delay	No Transmit Delay (0ms)	
End of Transmission Message	Off, EOT	
Auto Clear Stored Data after Transmission	Off	
Scanner Time	Set Date and Time	
Time Stamp	Do Not Send	
Time Stamp Format	Format 1: (YYYY/MM/DD,HH:MM:SS)	
Wireless Transmission Failure Beep	Enabled	
Bluetooth Connection Status	LED is on after Bluetooth connected	
Power-Off Timeout	5 minutes after inactivity	

AIM ID Table

Symbology	AIM ID	Possible AIM ID Modifiers (m)
Code 128]C0	
GS1-128 (UCC/EAN-128)]C1	
EAN-8]E4	
EAN-8 with Addon]E3	
EAN-13]E0	
EAN-13 with Addon]E3	
UPC-E]E0	
UPC-E with Addon]E3	
UPC-A]E0	
UPC-A with Addon]E3	
Interleaved 2 of 5]Im	0, 1, 3
ITF-14]Im	1, 3
ITF-6]Im	1, 3
Matrix 2 of 5]X0	
Code 39]Am	0, 1, 3, 4, 5, 7
Codabar]Fm	0, 2, 4
Code 93]G0	
China Post 25]X0	
AIM 128]C2	
ISBT 128]C4	
ISSN]X0	
ISBN]X0	
Industrial 25]S0	
Standard 25]R0	
Plessey]P0	
Code 11]Hm	0, 1, 3
MSI Plessey]Mm	0, 1
GS1 Composite]em	0-3
GS1 Databar (RSS)]e0	

Symbology	AIM ID	Possible AIM ID Modifiers (m)
PDF417]Lm	0-2
QR Code]Qm	0-6
Aztec]zm	0-9, A-C
Data Matrix]dm	0-6
Passport OCR]o2	

Note: “m” represents the AIM modifier character. Refer to ISO/IEC 15424:2008 Information technology – Automatic identification and data capture techniques – Data Carrier Identifiers (including Symbology Identifiers) for AIM modifier character details.

Code ID Table

Symbology	Code ID
Code128	j
GS1-128 (UCC/EAN-128)	j
EAN-8	d
EAN-13	d
UPC-E	c
UPC-A	c
Interleaved 2 of 5	e
ITF-14	e
ITF-6	e
Matrix 2 of 5	v
Code 39	b
Codabar	a
Code 93	i
China Post 25	X
AIM 128	X
ISBT 128	X
ISSN	g
ISBN	B
Industrial 25	l
Standard 25	f
Plessey	n
Code 11	H
MSI Plessey	m
GS1 Composite	y
GS1 Databar (RSS)	R
PDF417	r
QR Code	s
Aztec	z
Data Matrix	u
Passport OCR	O

Symbology ID Number

Symbology	ID Number
Code 128	002
GS1-128 (UCC/EAN-128)	003
EAN-8	004
EAN-13	005
UPC-E	006
UPC-A	007
Interleaved 2 of 5, Febraban	008
ITF-14	009
ITF-6	010
Matrix 2 of 5	011
Code 39, Code 32	013
Codabar	015
Code 93	017
China Post 25	019
AIM 128	020
ISBT 128	021
ISSN	023
ISBN	024
Industrial 25	025
Standard 25	026
Plessey	027
Code11	028
MSI-Plessey	029
GS1 Composite	030
GS1 Databar (RSS)	031
PDF417	032
QR Code	033
Aztec	034
Data Matrix	035
Maxicode	036
Chinese Sensible Code	039
GM Code	040

Symbology	ID Number
Micro PDF417	042
Micro QR	043
Code One	048
Passport OCR	066

ASCII Table

HEX	Dec	Char
00	0	NUL (Null char.)
01	1	SOH (Start of Header)
02	2	STX (Start of Text)
03	3	ETX (End of Text)
04	4	EOT (End of Transmission)
05	5	ENQ (Enquiry)
06	6	ACK (Acknowledgment)
07	7	BEL (Bell)
08	8	BS (Backspace)
09	9	HT (Horizontal Tab)
0a	10	LF (Line Feed)
0b	11	VT (Vertical Tab)
0c	12	FF (Form Feed)
0d	13	CR (Carriage Return)
0e	14	SO (Shift Out)
0f	15	SI (Shift In)
10	16	DLE (Data Link Escape)
11	17	DC1 (XON) (Device Control 1)
12	18	DC2 (Device Control 2)
13	19	DC3 (XOFF) (Device Control 3)
14	20	DC4 (Device Control 4)
15	21	NAK (Negative Acknowledgment)
16	22	SYN (Synchronous Idle)
17	23	ETB (End of Trans. Block)
18	24	CAN (Cancel)
19	25	EM (End of Medium)
1a	26	SUB (Substitute)
1b	27	ESC (Escape)

1c	28	FS (File Separator)
1d	29	GS (Group Separator)
1e	30	RS (Request to Send)
1f	31	US (Unit Separator)
20	32	SP (Space)
21	33	! (Exclamation Mark)
22	34	" (Double Quote)
23	35	# (Number Sign)
24	36	\$ (Dollar Sign)
25	37	% (Percent)
26	38	& (Ampersand)
27	39	` (Single Quote)
28	40	((Right / Closing Parenthesis)
29	41) (Right / Closing Parenthesis)
2a	42	* (Asterisk)
2b	43	+ (Plus)
2c	44	, (Comma)
2d	45	- (Minus / Dash)
2e	46	. (Dot)
2f	47	/ (Forward Slash)
30	48	0
31	49	1
32	50	2
33	51	3
34	52	4
35	53	5
36	54	6
37	55	7
38	56	8
39	57	9
3a	58	: (Colon)
3b	59	; (Semi-colon)
3c	60	< (Less Than)
3d	61	= (Equal Sign)

3e	62	> (Greater Than)
3f	63	? (Question Mark)
40	64	@ (AT Symbol)
41	65	A
42	66	B
43	67	C
44	68	D
45	69	E
46	70	F
47	71	G
48	72	H
49	73	I
4a	74	J
4b	75	K
4c	76	L
4d	77	M
4e	78	N
4f	79	O
50	80	P
51	81	Q
52	82	R
53	83	S
54	84	T
55	85	U
56	86	V
57	87	W
58	88	X
59	89	Y
5a	90	Z
5b	91	[(Left / Opening Bracket)
5c	92	\ (Back Slash)
5d	93] (Right / Closing Bracket)
5e	94	^ (Caret / Circumflex)
5f	95	_ (Underscore)
60	96	' (Grave Accent)
61	97	a
62	98	b
63	99	c
64	100	d
65	101	e

66	102	f
67	103	g
68	104	h
69	105	i
6a	106	j
6b	107	k
6c	108	l
6d	109	m
6e	110	n
6f	111	o
70	112	p
71	113	q
72	114	r
73	115	s
74	116	t
75	117	u
76	118	v
77	119	w
78	120	x
79	121	y
7a	122	z
7b	123	{ (Left/ Opening Brace)
7c	124	(Vertical Bar)
7d	125	} (Right/Closing Brace)
7e	126	~ (Tilde)
7f	127	DEL (Delete)

Unicode Key Maps

6E	70	71	72	73	74	75	76	77	78	79	7A	7B	7C	7D	7E	•	•	•		
01	02	03	04	05	06	07	08	09	0A	0B	0C	0D	0F	4B	50	55	5A	5F	64	69
10	11	12	13	14	15	16	17	18	19	1A	1B	1C	1D	4C	51	56	5B	60	65	6A
1E	1F	20	21	22	23	24	25	26	27	28	29	2B				5C	61	66		
2C	2E	2F	30	31	32	33	34	35	36	37	39		53			5D	62	67	6C	
3A	3B	3C	3D				3E	3F	38	40	4F	54	59	63	68					

104 Key U.S. Style Keyboard

6E	70	71	72	73	74	75	76	77	78	79	7A	7B	7C	7D	7E	•	•	•		
01	02	03	04	05	06	07	08	09	0A	0B	0C	0D	0F	4B	50	55	5A	5F	64	69
10	11	12	13	14	15	16	17	18	19	1A	1B	1C	2B	4C	51	56	5B	60	65	6A
1E	1F	20	21	22	23	24	25	26	27	28	29	1D				5C	61	66		
2C	2D	2E	2F	30	31	32	33	34	35	36	37	39	53			5D	62	67	6C	
3A	3B	3C	3D				3E	3F	38	40	4F	54	59	63	68					

105 Key European Style Keyboard

Newland AIDC

📍 No.1 Rujiang West Rd., Mawei, Fuzhou, Fujian 350015, China

☎ +86-591-83979500

✉ info@nlscan.com

🌐 www.newlandaidc.com

Asia Pacific

Taiwan:

Add: 7F-6, No. 268, Liancheng Rd.,
Jhonghe Dist. 235, New Taipei City,
Taiwan

Tel: +886 2 7731 5388

Email: info@nlscan.com

India:

Add: 416 & 417, Tower C, NOIDA ONE
business park, B-8, Sector 62, Noida,
Uttar Pradesh - 201301

Tel: +91 120 3508102

Email: info@nlscan.com

Korea:

Add: Biz. Center Best-one, Jang-eun Medical
Plaza 6F, Bojeong-dong 1261-4, Kihung-gu,
Yongin-City, Kyunggi-do, South Korea

Tel: +82 10 8990 4838

Email: info@nlscan.com

Japan:

Add: Room 407 Area Shinagawa Building
13th Floor, 9-36 Konan 1-chome, Minato-ku,
Tokyo, Japan 108-0075

Tel: +81 03 4405 3222

Email: info@nlscan.com

Europe & Middle East & Africa

Add: Rolweg 25, 4104 AV Culemborg, The Netherlands

Tel: +31 (0) 345 87 00 33

Email: sales@newland-id.com

Tech Support: tech-support@newland-id.com

Web: www.newland-id.com

North America

Add: 46559 Fremont Blvd., Fremont, CA 94538, USA

Tel: +1 510 490 3888

Email: info@nlscan.com

Latin America

Tel: +1 239 598 0068

Email: Info@NewlandLA.com

Brazil:

Tel: +55 35 9767 6078

Email: Info@NewlandLA.com

Colombia:

Tel: +57 319 387 4484

Email: Colombia@NewlandLA.com

Chile:

Tel: +56 9 9337 3177

Email: Chile@NewlandLA.com

Mexico, Central America & Caribbean:

Tel: +52 155 5432 9079

Email: Mexico@NewlandLA.com

