



# Newland

SCANNING MADE SIMPLE



## MT93 Megattera Pro

Mobile Computers

User Guide

Version:V1.0.1.

# Disclaimer

© 2024 Newland Auto-ID Tech. Co., Ltd. All rights reserved.

Please read through the manual carefully before using the product and operate it according to the manual. It is advised that you should keep this manual for future reference.

Do not disassemble the device or remove the seal label from the device, doing so will void the product warranty provided by Newland Auto-ID Tech. Co., Ltd.

All pictures in this manual are for reference only and actual product may differ. Regarding the product modification and update, Newland Auto-ID Tech. Co., Ltd. reserves the right to make changes to any software or hardware to improve reliability, function, or design at any time without notice. The information contained herein is subject to change without prior notice.

The products depicted in this manual may include software copyrighted by Newland Auto-ID Tech. Co., Ltd or third party. The user, corporation or individual, shall not duplicate, in whole or in part, distribute, modify, decompile, disassemble, decode, reverse engineer, rent, transfer or sublicense such software without prior written consent from the copyright holders.

This manual is copyrighted. No part of this publication may be reproduced, distributed, or used in any form without written permission from Newland.

## **Risk Warning Regarding Unauthorized System Updates:**

You should use the Newland-provided tool to update this product's system. Modifying system files through installing a third-party ROM system or using any cracking method may result in product malfunction or data loss and this will void your warranty.

Newland Auto-ID Tech. Co., Ltd. reserves the right to make final interpretation of the statement above.

Newland Auto-ID Tech. Co., Ltd.

No.1, Rujiang West Rd., Mawei, Fuzhou, Fujian, China 350015

<http://www.newlandaidc.com>

## Revision History

Version	Description	Date
V1.0	Initial Release.	2024-02-19

# Contents

<b>Chapter 1 About This Guide .....</b>	<b>1</b>
Introduction .....	1
Documentation Set.....	1
Chapter Descriptions.....	1
More Information.....	2
<b>Chapter 2 Getting Started .....</b>	<b>3</b>
Introduction .....	3
Getting Started.....	3
The MT93 .....	3
Charging Cradle for PDA .....	5
Charging Cradle for Battery .....	6
Installing the Battery .....	7
Removing the Battery .....	7
Charging the Mobile Terminal .....	8
Charging the 4-Slot Charging Cradle .....	10
Keypad.....	11
Communicating with PC.....	12
Installing the MicroSD Card/SIM Card .....	13
<b>Chapter 3 Basics .....</b>	<b>14</b>
Introduction .....	14
Switching On/Rebooting/Switching Off the MT93.....	14
Locking/Unlocking the MT93.....	15
Home Screen .....	16
Status Icons .....	17
Installing App.....	18
Uninstalling App .....	18
Date & Time .....	19
Display .....	20
Ringtones.....	21
Restoring Factory Settings .....	22
Language & Input Method.....	23
Shortcuts to Apps.....	24
Widgets .....	24
<b>Chapter 4 Scanning Barcodes .....</b>	<b>25</b>

Introduction .....	25
Scanning 1D Barcode .....	25
Scanning 2D Barcode .....	26
Programming Scanner .....	27
Enable Scan.....	28
Output Mode .....	28
Scan Mode .....	30
Scan Trigger.....	31
Prefix & Suffix.....	32
Good Read Indicator .....	33
Encoding .....	34
Data Edit .....	35
Broadcast-output Settings.....	36
Symbologies.....	37
<b>Chapter 5 Bluetooth .....</b>	<b>40</b>
Introduction .....	40
Pair Bluetooth.....	40
<b>Chapter 6 Wi-Fi .....</b>	<b>42</b>
Introduction .....	42
Join a Wi-Fi Network .....	42
Wi-Fi Settings .....	44
Metered.....	45
Proxy.....	46
IP Settings.....	47
Add Network.....	49
Wi-Fi Preferences .....	51
Saved Networks .....	52
Wi-Fi Data Usage.....	53
<b>Chapter 7 Mobile Network .....</b>	<b>54</b>
Introduction .....	54
Mobile Network Settings .....	54
APN Settings.....	55
<b>Chapter 8 Others .....</b>	<b>57</b>
Camera .....	57
GPS .....	58
NFC.....	59
<b>Chapter 9 Whitelist Manager .....</b>	<b>60</b>

Introduction .....	60
Logging in to Whitelist Manager .....	60
<b>Chapter 10 System Update .....</b>	<b>61</b>
Introduction .....	61
Online Update .....	61
Local Update .....	62
<b>Chapter 11 App Development Guide.....</b>	<b>66</b>
Development Environment .....	66
Use of Non-standard Interfaces .....	66
<b>Chapter 12 Maintenance &amp; Troubleshooting.....</b>	<b>67</b>
Introduction .....	67
Important Safety & Handling Information .....	67
Disassembly and Retrofit .....	67
External Power Supply.....	67
Abnormal Situation.....	67
Drop Damage.....	67
LCD Screen .....	67
Stacking Heavy Objects.....	67
Mounting Location.....	67
Wireless Functionalities .....	68
Use & Maintenance.....	68
Battery Safety Guidelines .....	68
Troubleshooting .....	70

# Chapter 1 About This Guide

## Introduction

This guide provides instructions for programming and operating the NLS-MT93 portable data collector (hereinafter referred to as “the MT93” or “the terminal”).

## Documentation Set

The documentation set for the **MT93** includes:

- ✧ **NLS-MT93 Portable Data Collector Quick Start:** Describes how to get the NLS-MT93 up and running.
- ✧ **NLS-MT93 Portable Data Collector User Guide:** Describes how to program and use the NLS-MT93.
- ✧ **Newland APP User Guide:** Describes how to install/uninstall, or use the APPs developed by Newland (For GMS Version Only)

## Chapter Descriptions

- ✧ *Chapter 1 About This Guide* Provides a general description of this manual.
- ✧ *Chapter 2 Getting Started* Provides information on getting the MT93 up and running for the first time.
- ✧ *Chapter 3 Basics* Describes how to program the MT93 for the use of its basic features.
- ✧ *Chapter 4 Scanning Barcodes* Provides the instructions as to how to scan 1D/2D barcodes and how to program the scanner.
- ✧ *Chapter 5 Bluetooth* Explains how to use Bluetooth functionality.
- ✧ *Chapter 6 Wi-Fi* Explains how to use Wi-Fi functionality.
- ✧ *Chapter 7 Mobile Network* Explains how to use Mobile Network functionality.
- ✧ *Chapter 8 Others* Explains how to use Camera, GPS, and NFC functionalities.
- ✧ *Chapter 9 Whitelist Manager* Explains how to use the whitelist management tool.

- 
- ✧ *Chapter 10 System Update* Explains how to update the system.
  - ✧ *Chapter 11 App Development Guide* Describes the app development environment and the use of non-standard interfaces.
  - ✧ *Chapter 12 Maintenance & Troubleshooting* Provides troubleshooting solutions for issues that might occur when using the MT93.

## **More Information**

For more product and support information, please visit our website: <http://www.newlandaidc.com>.



## Chapter 2 Getting Started

### Introduction

This chapter lists the parts and accessories for the MT93 and explains how to install, remove, and charge the battery, and power on the MT93 for the first time.

### Getting Started

#### The MT93

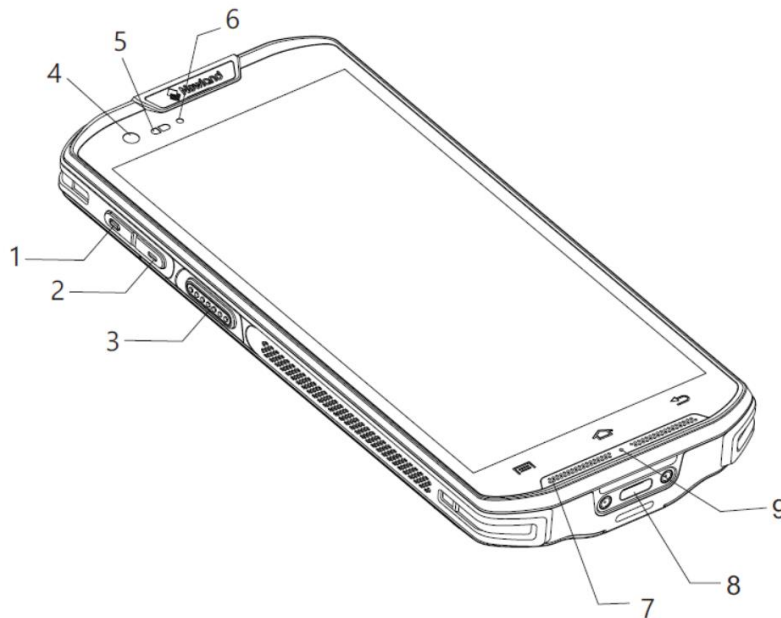

1	Volume+	2	Volume-
3	Left Scan Key	4	Front Camera
5	Light/Proximity Sensors	6	LED
7	Speaker	8	USB Type-C Connector
9	Main Microphone		

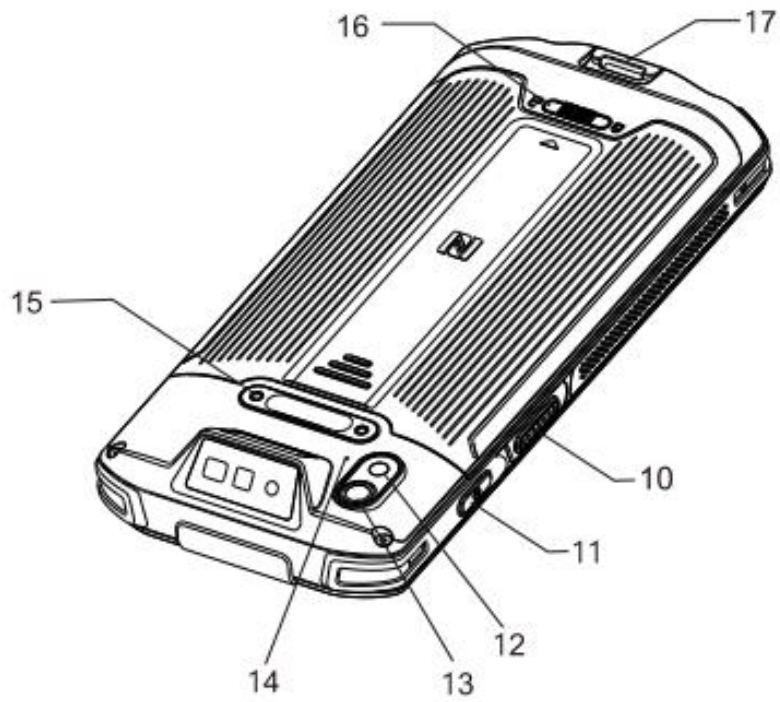

---

<b>10</b>	Right Scan Key	<b>11</b>	Power Key
<b>12</b>	Flashlight	<b>13</b>	Rear Camera
<b>14</b>	Noise Reduction Microphone	<b>15</b>	Hand strap installation position
<b>16</b>	Battery Cover Latch	<b>17</b>	Lanyard hole

---

## Charging Cradle for PDA

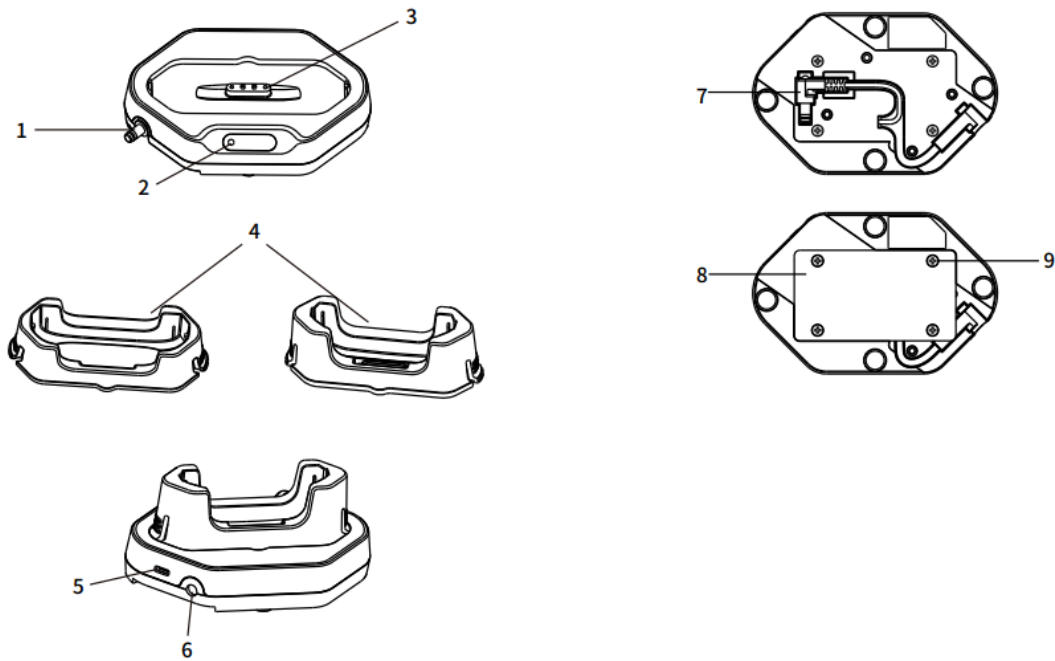

1	DC Plug	2	LED Power Indicator
3	Charging Contacts	4	Interchangeable Device Holder
5	USB Type-C Port	6	DC Jack
7	Connection Cable	8	Counterweight
9	Screw		

---

## Charging Cradle for Battery

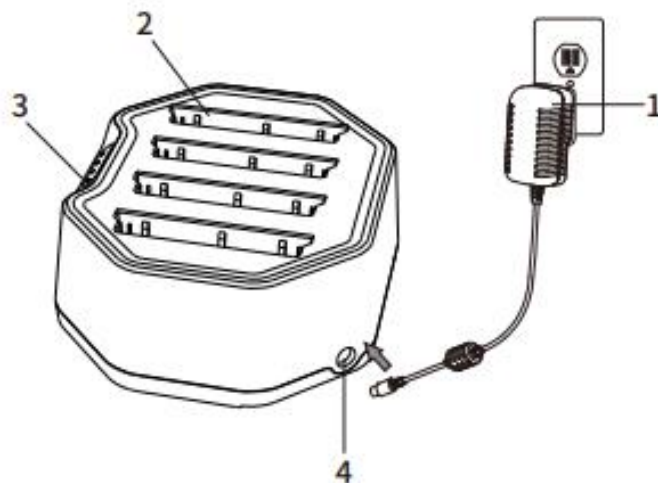

---

1 AC Adapter

2 Charging Slot

3 LED Power Indicator

4 DC Jack

---

---

## Installing the Battery

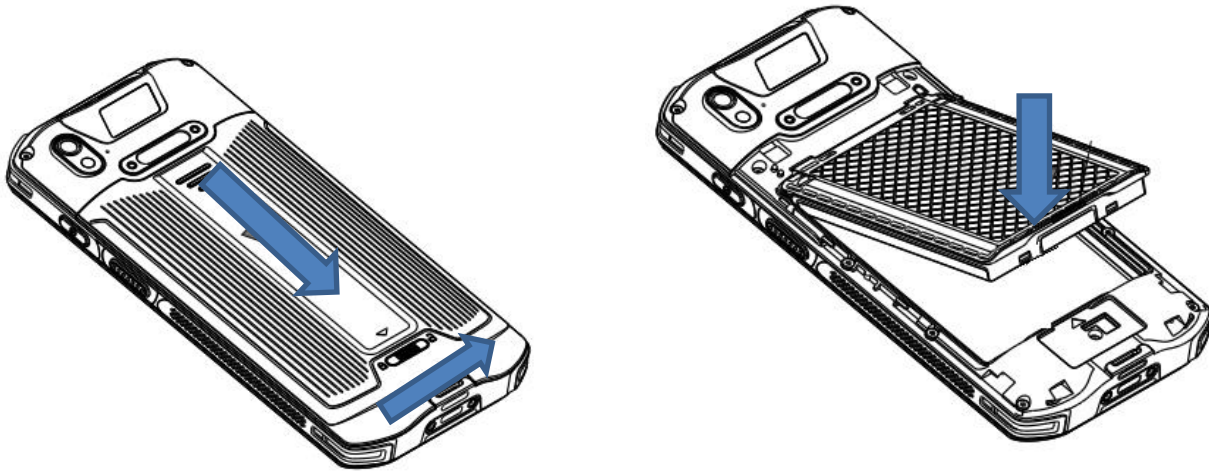

Step 1: Slide the battery cover latch to the unlock position and remove the cover.

Step 2: Insert the battery as indicated into the battery compartment, with its metal contacts facing down and lining up with the metal contacts on the inside of the terminal.

## Removing the Battery

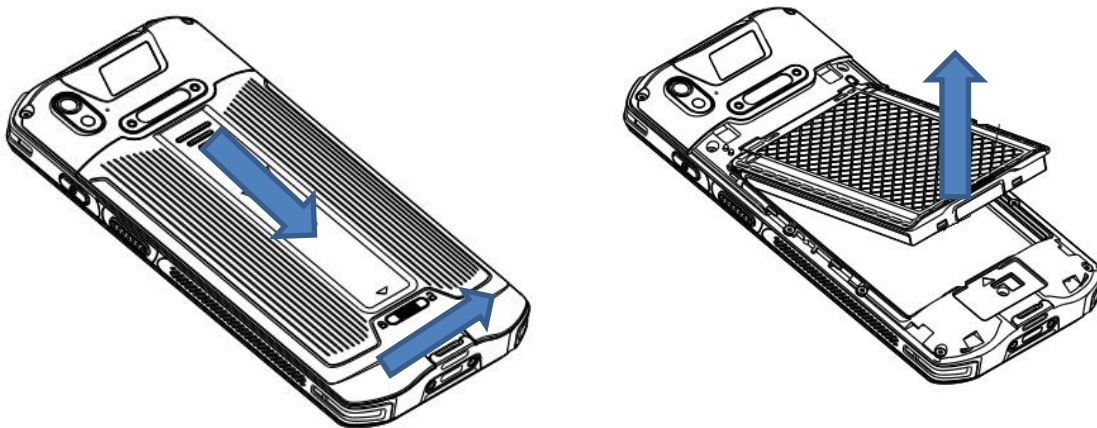

Step 1: Hold down the Power key for 5 seconds and then tap "Power off" to turn off the terminal. Slide the battery cover latch to the unlock position and remove the cover.

Step 2: Remove the battery.

---

## Charging the Mobile Terminal

### ✧ Charge with power adapter

Connect the MT93 to a power outlet using the included AC adapter or USB cable. When the terminal's battery is less than 5%, it takes about 3 hours to fully charge it (The terminal is shut down or in sleep mode).

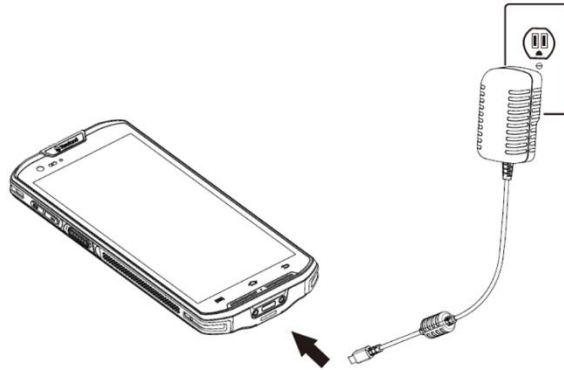

**Note:** Low battery may result in a malfunction of the terminal. Before your first use, charge the battery for at least 6 hours.

When charging the MT93 with an AC adapter or USB cable, the user is notified of the charging status by the LEDs on the terminal.

---

✧ Charge with charging cradle

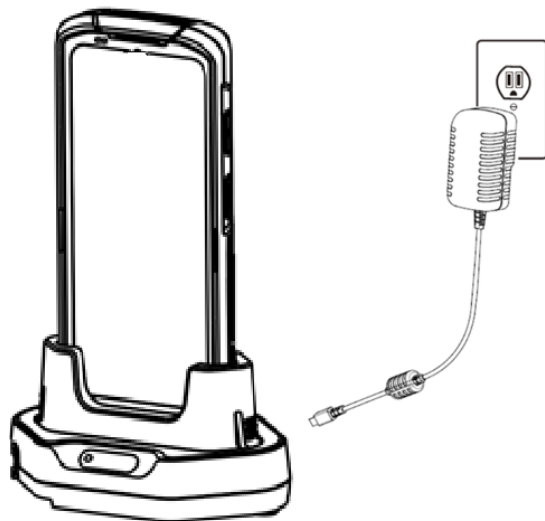

Step 1: Insert the NLS-MT93 into the charging slot.

Step 2: Connect the charging cradle to a power outlet using the USB cable/AC adapter.

**Note:** The charging cradles can be assembled up to 4 units. To charge the assembled cradles, 19V, 3.2A power adapter is required (need to purchased separately).

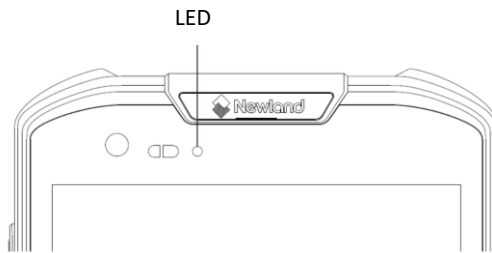

Charging/Battery Status	
Blue LED on	Fully charged
Red LED on	Charging in progress
Red LED flashes constantly	Low-battery alert
Blue LED flashes constantly	Phone call/message coming

**Note:**

1. If MT93 battery is completely drained, please press the power key to turn it on after 15 minutes of being charged.
2. When charging, make sure that the indoor temperature is above 0 degrees Celsius (32 degrees Fahrenheit). The device will stop charging at a low temperature for safety consideration.

**Charging the 4-Slot Charging Cradle**

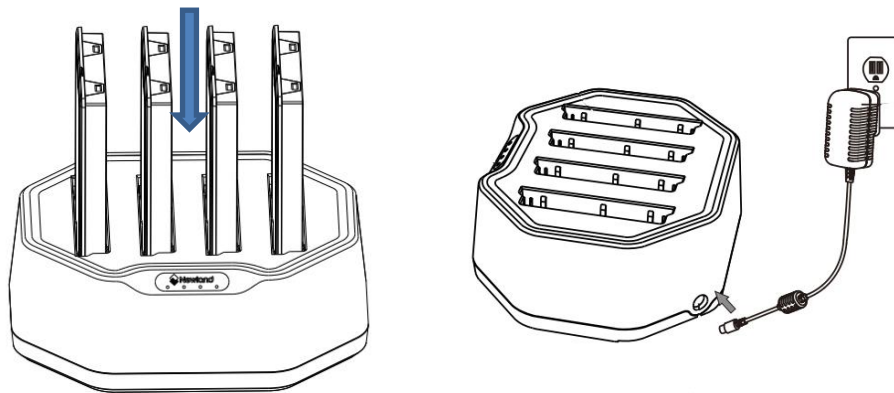

Step 1: Insert the battery as indicated into the charging slot, with its metal contacts facing down and lining up with the metal contacts on the inside of the charging cradle.

Step 2: Connect the 4-slot battery charging cradle to a power outlet using the included AC adapter (19V,3.2A).



---

## Keypad

The MT93 has 5 physics keys, Volume+/Volume-/Scan keys on the left side, and Power/Scan key on the right side.

**Note:** Except the Power key, other keys are user programmable.

---

## Communicating with PC

Step 1: Connect the USB port on the MT93 to your computer with the included USB cable.

Step 2: Switch the MT93 on. On the Home screen, swipe from top to bottom with one finger in one smooth motion to open the notification bar as shown below.

Step 3: Tap “Android System” then “Charging this device via USB, Tap for more options”.

Step 4: Select “Transfer files”. Navigate to the “My Computer” section of your computer and look for the newly added drive. Double-click it and you will be connected to the MT93. Then you may handle the files on the terminal through your computer.

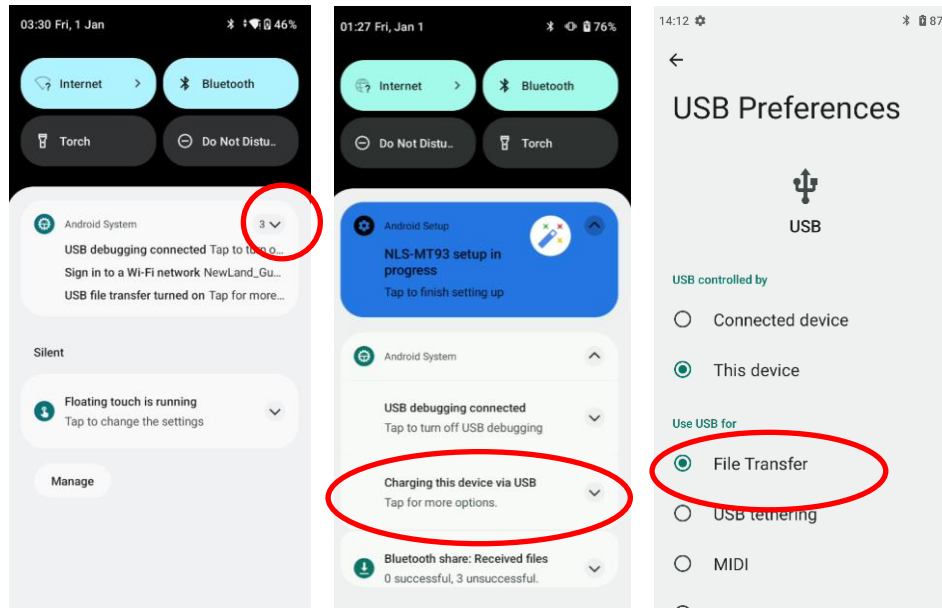

---

## Installing the MicroSD Card/SIM Card

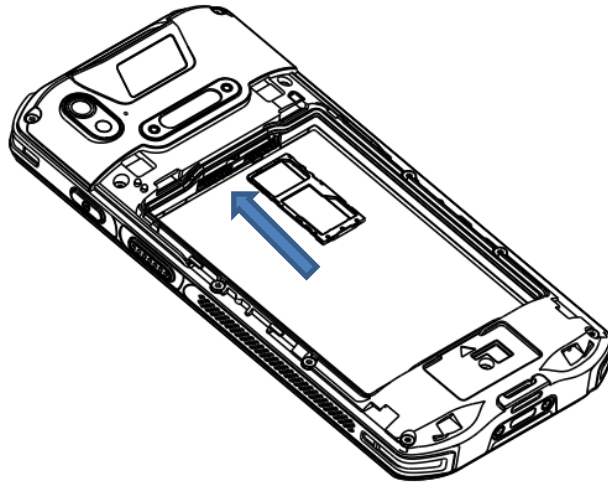

Step 1: Slide the battery cover latch to the unlock position and remove the cover.

Step 2: Pull the tray out from the SIM card slot.

Step 2: Insert the Nano SIM card into the tray and then gently push the tray all the way into the slot until it locks in place.

**Note:** There are three kinds of SIM cards in the market:

1. **SIM:** Size 25mm × 15mm × 0.8mm
2. **Micro SIM:** Size 12mm × 15mm × 0.8mm
3. **Nano SIM:** Size 12.3mm × 8.8mm × 0.7mm

MT93 can only support **Nano SIM**.



## Chapter 3 Basics

### Introduction

This chapter provides the basics of setting and using the MT93

### Switching On/Rebooting/Switching Off the MT93

After installing the SIM card and battery and having the MT93 fully charged, you may switch the terminal on.

**Switch the MT93 on:** Hold down the Power key on the right side of the terminal until the Android logo is displayed. Note that the initialization is going to take some time before the MT93 displays the Home screen.

**Reboot the MT93:** Hold down the Power key on the right side of the terminal until the window below pops up, then tap “Restart”.

**Switch the MT93 off:** Hold down the Power key on the right side of the terminal until the window below pops up, then tap “Power off”.

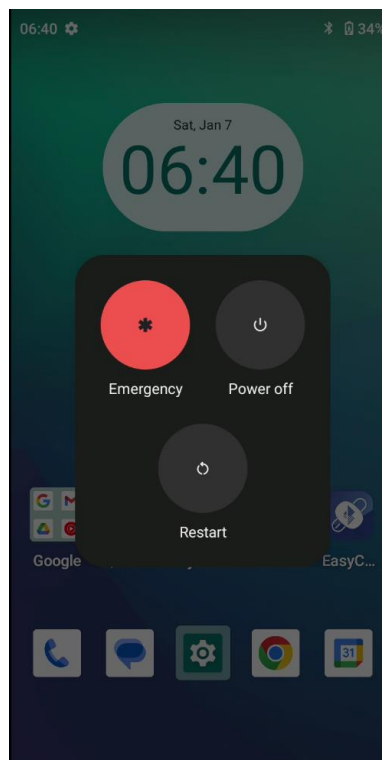

---

## Locking/Unlocking the MT93



Tap the app icon  and then “Security” -> “Screen lock” and set the screen lock mode per your needs.

**Lock the MT93:** Briefly press the Power key on the right side of the terminal. If no operation is performed on the MT93 for a preset period, the MT93 will lock automatically and enter sleep mode to save power.

**Unlock the MT93:** Briefly press the Power key on the right side of the terminal and swipe up from the bottom of the screen to enter the screen lock mode, then unlock it per the previous setting mode.

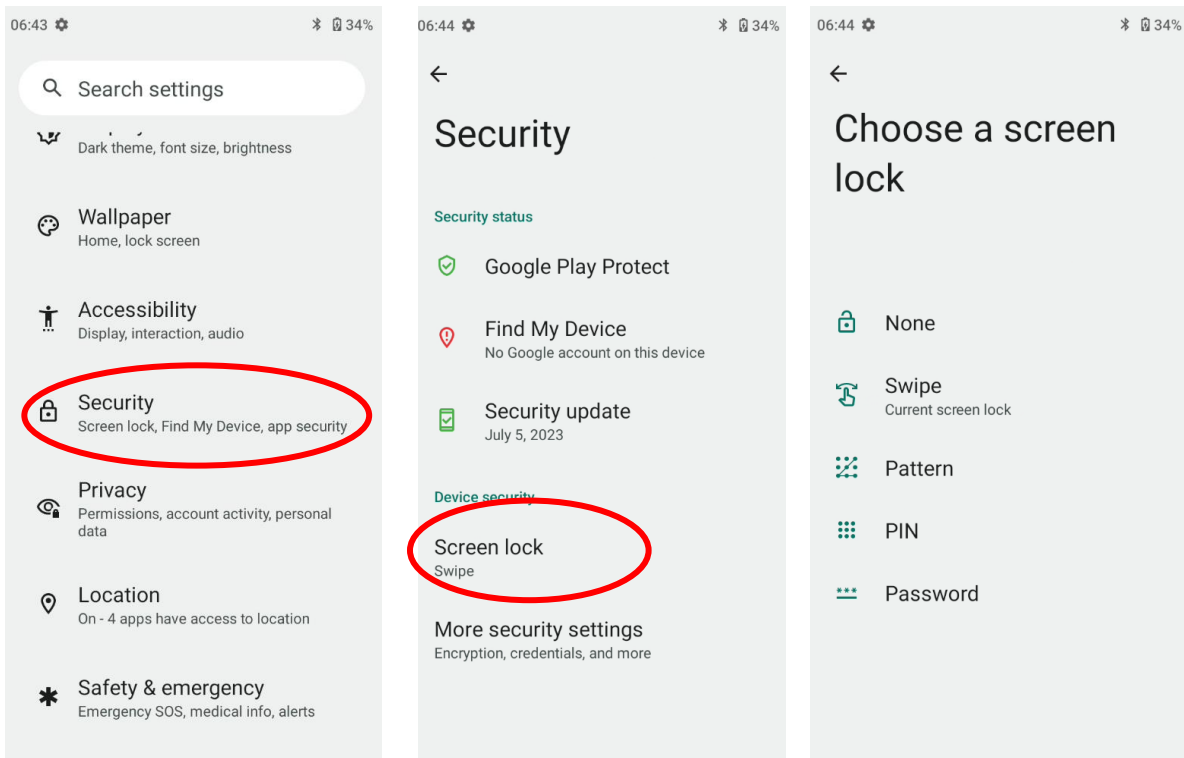

---

## Home Screen

**View another Home screen:** Swipe left or right.

**Go to the Home screen:** Tap the Home key.

**Open an app:** Tap it.

**View all apps/Open apps list:** Swipe up from the bottom of the screen to view all the apps.

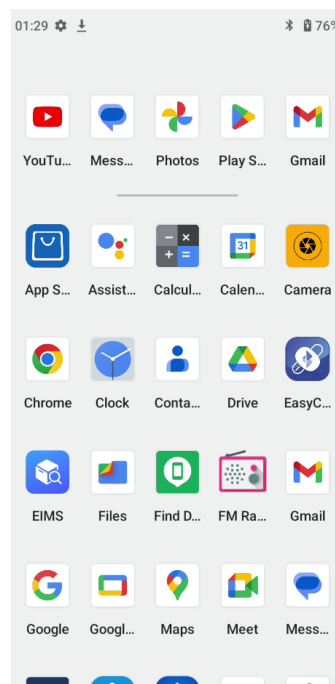
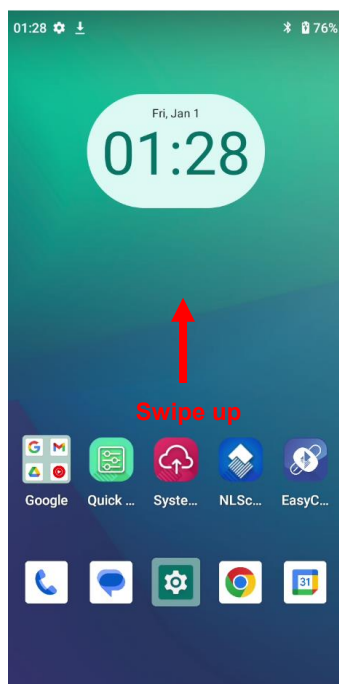











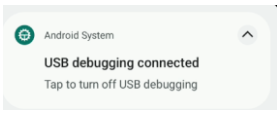

**Apps list**

**Add an app icon to the Home screen:** Swipe up from the bottom of the screen to view all the apps. Tap and hold your desired app until it appears on the Home screen and then drag it into a blank area.

**Delete an app icon on the Home screen:** Tap and hold your desired app on the Home screen until "X Remove" appears, then drag the app into it. Note that this operation only removes the icon from the Home screen. To remove the app from the MT93, see the **Uninstalling App** section.

## Status Icons

The icons in the notification bar at the top of the screen give information about the MT93.

Status Icon	Description	Status Icon	Description
	WLAN on		Signal Strength
	Bluetooth on		Airplane Mode on
	USB Connected		USB Debugging
	Missed Calls		Battery Charging in Progress
	New Message		Hotspot & Tethering
	Positioning		Power Saving Mode
	Don't Disturb Mode		Vibrate on

---

## Installing App

Use one of the following methods to install a new app on the MT93:

1. Download an APK file from the online app store and install it.
2. Download software package onto a MicroSD card or PC and copy it to your terminal. Then install it with File Manager.
3. Install Newland app using NInstaller APP installed on the PC.

## Uninstalling App

Follow the procedure below to remove an app from the MT93:

Swipe Home screen from bottom to top with one finger in one smooth motion to view all the apps. Tap and hold your desired app until “App info” appears, then tap “UNINSTALL” and uninstall it

\*The application that comes with the system cannot be uninstalled.

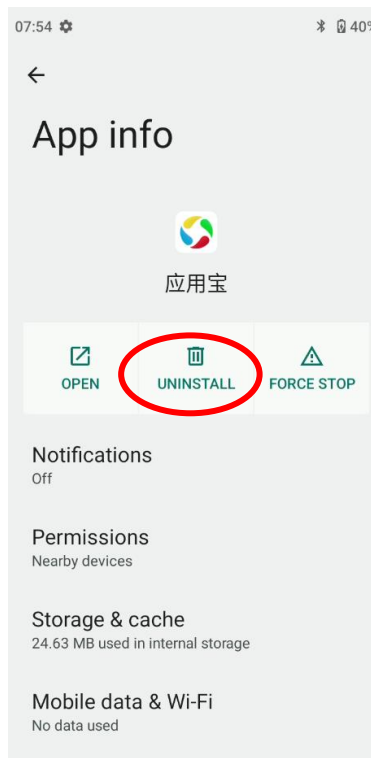
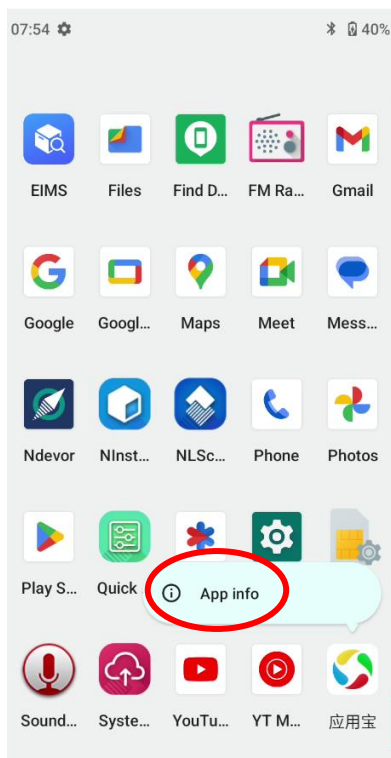



---

## Date & Time

**Set the date and time:** Tap the app icon  and then “System” -> “Date & time” and set the date and time on the screen shown below as per your needs.

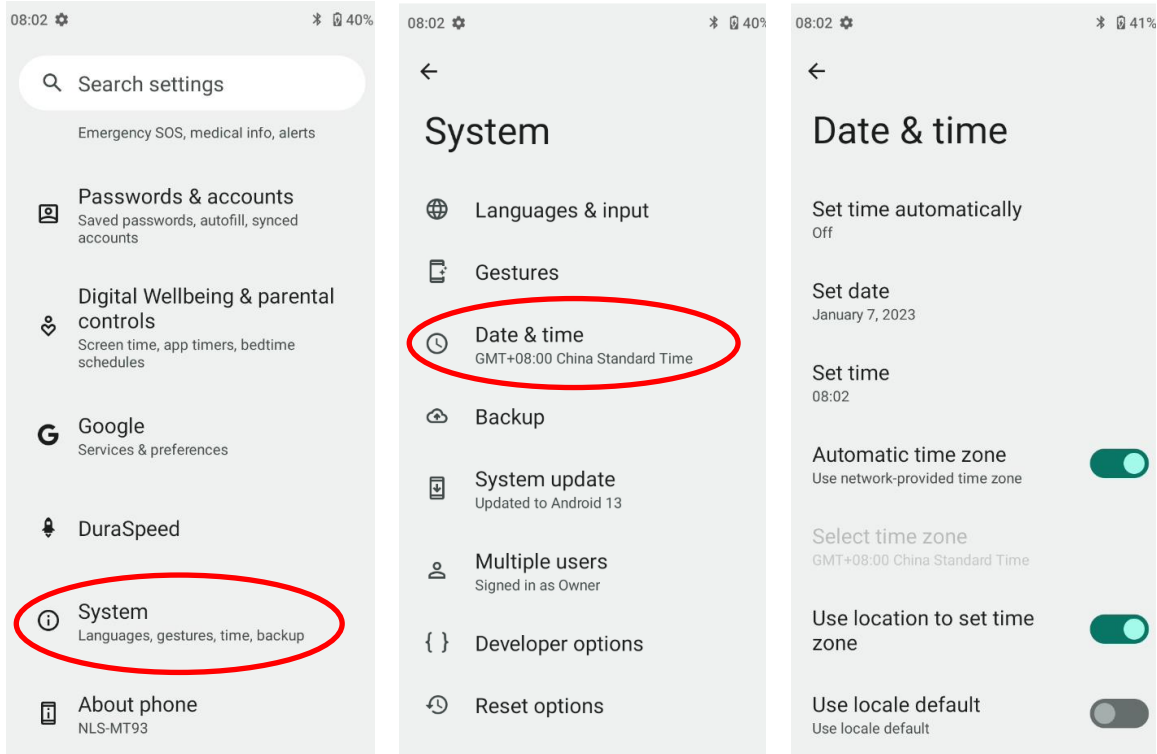

---

## Display

Tap the app icon  and then “Display”, and set the brightness level, dark theme, night light, adaptive brightness, and other parameters on the screen shown below as per your needs.

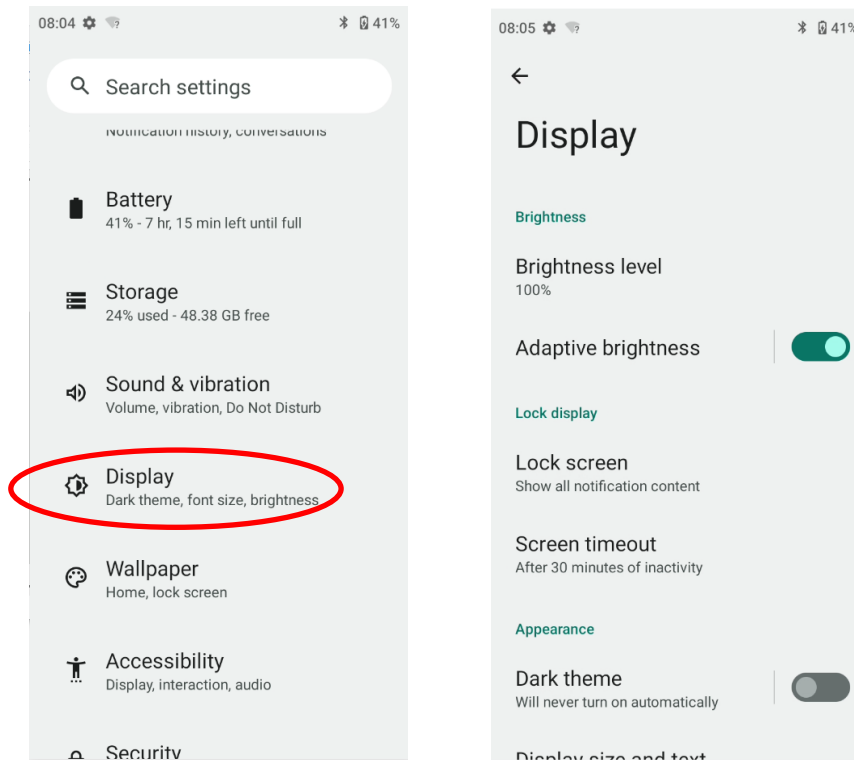

---

## Ringtones

Tap the app icon  -> "Sound". Then set the ringtones and other notification sounds as per your needs.

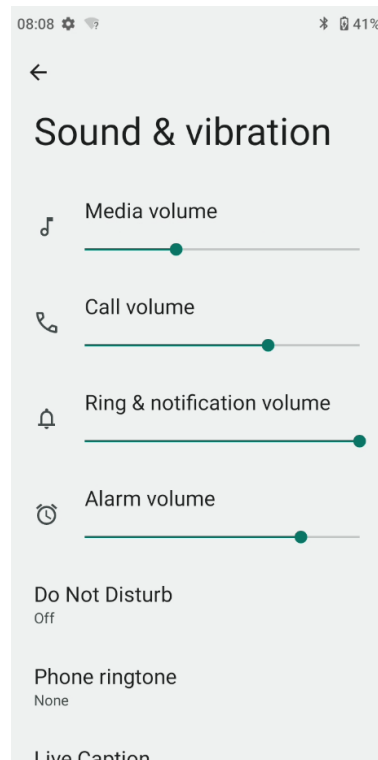
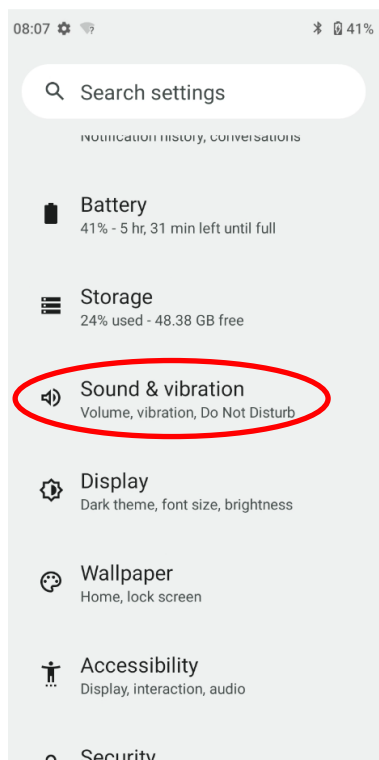

## Restoring Factory Settings

Tap the app icon  -> "System" -> "Reset options" -> "Erase all data (factory reset)" -> "Erase all data". After this operation, the terminal will be reset to factory defaults and all the personal data on the internal storage, such as music and photos, will be deleted.

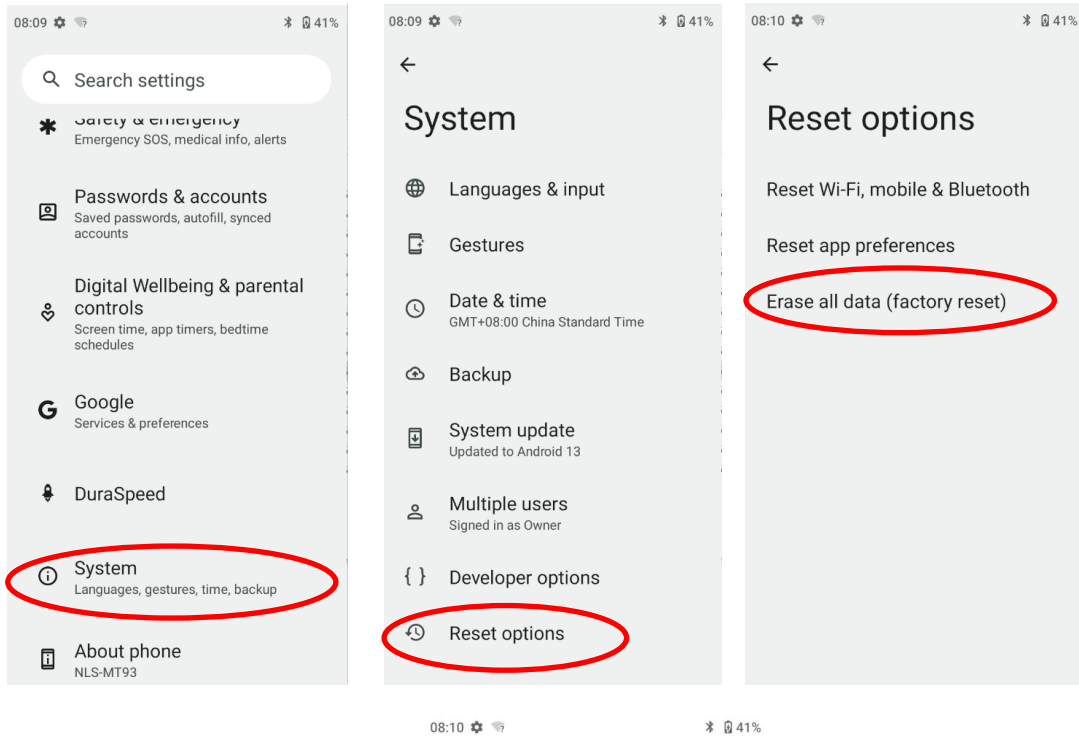

### Erase all data (factory reset)

This will erase all data from your phone's **internal storage**, including:

- Your Google Account
- System and app data and settings
- Downloaded apps
- Music
- Photos
- Other user data

 The button 'Erase all data' is circled in red.

---

## Language & Input Method

Tap the app icon  -> "System"-> "Languages & input". Then set the language and input method as per your needs.

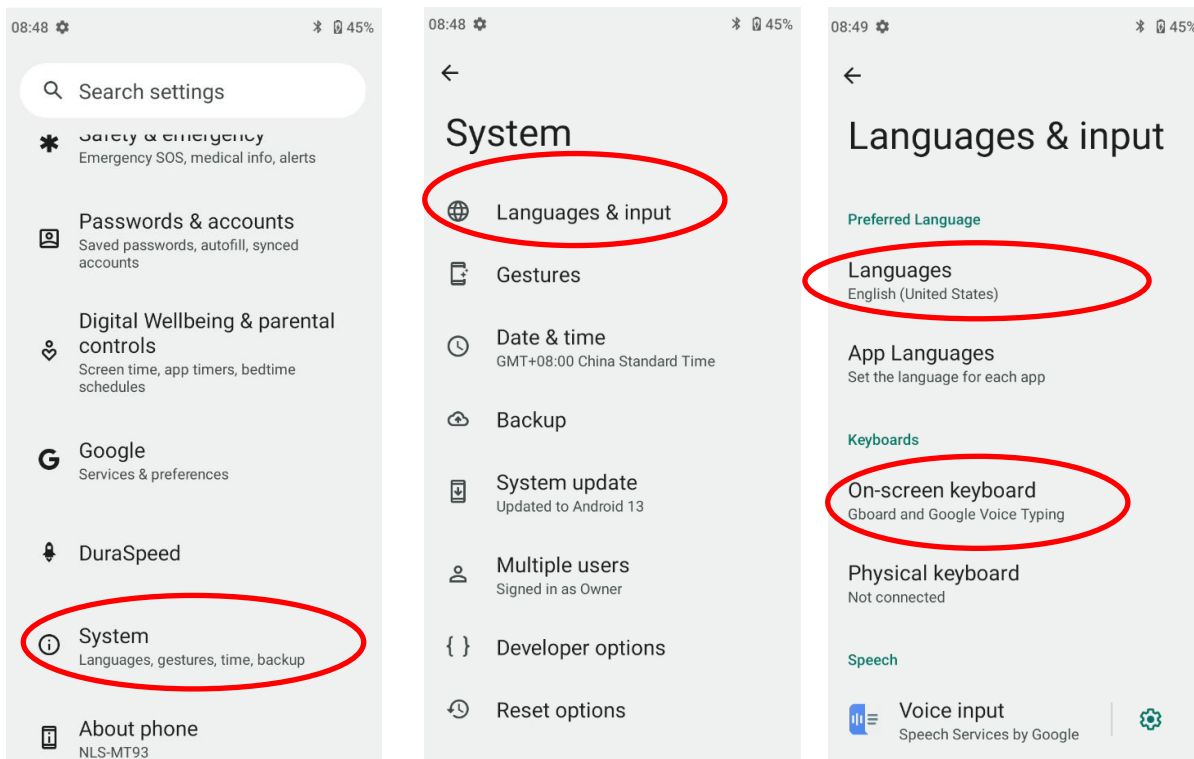

## Shortcuts to Apps

**Create a shortcut to an app on your Home screen:** On the home screen, swipe up from the bottom to top with one finger in one smooth motion to view all apps. Tap and hold your desired app and then drag it into the Home screen.

## Widgets

**View all widgets:** Tap and hold on a blank area of the Home screen and then tap. 

**Open a widget:** Tap it.

**Add a widget icon to the Home screen:** Tap and hold the Home screen and then tap . Find your desired widget and tap

 and then long press to move the wide.

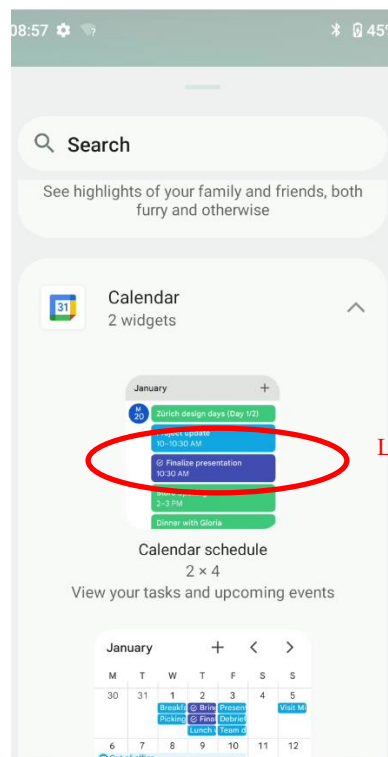
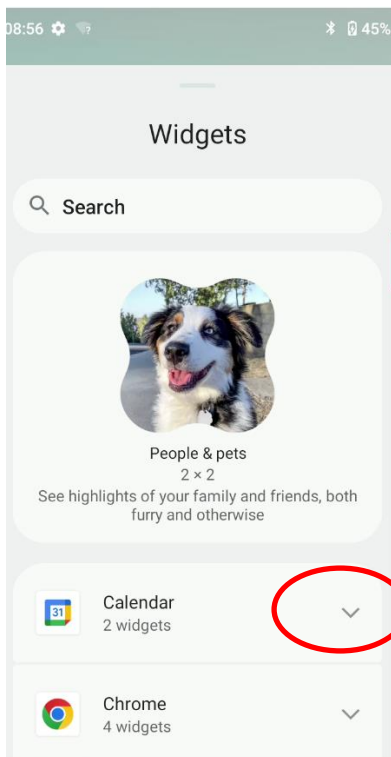
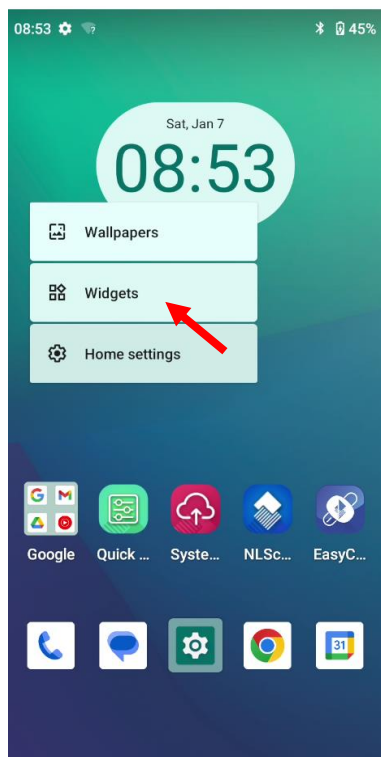

# Chapter 4 Scanning Barcodes

## Introduction

This chapter includes scanning tips and instructions for setting up the scanner.

## Scanning 1D Barcode

Adjust the scan angle or the distance between the MT93 and the target barcode to ensure the length of the laser beam is roughly 8mm greater than that of the barcode, as shown below.



Correct	Wrong

---

## Scanning 2D Barcode

Adjust the scan angle and the distance between the MT93 and the target barcode to make them fall into the following ranges:

1. Point the MT93's focus lamp at the center of the barcode.
2. Move the MT93 until you find the appropriate scan distance.
3. Optimum scan angles:

Skew ( $\alpha$ ) < 45° (0° preferably)

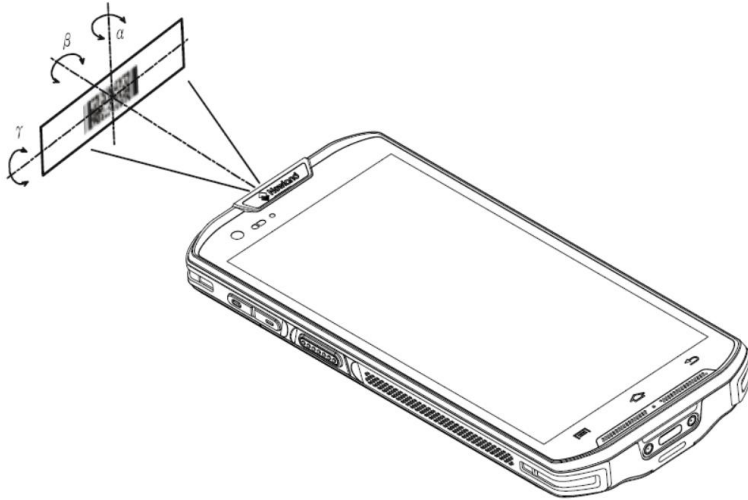

Pitch ( $\gamma$ ) < 45° (5° - 20° preferably)

Roll ( $\beta$ ) = 0° - 360°





## Programming Scanner

Tap the app icon  on the Home screen ->  Scan Settings. Then configure the scanner parameters as per your actual needs.

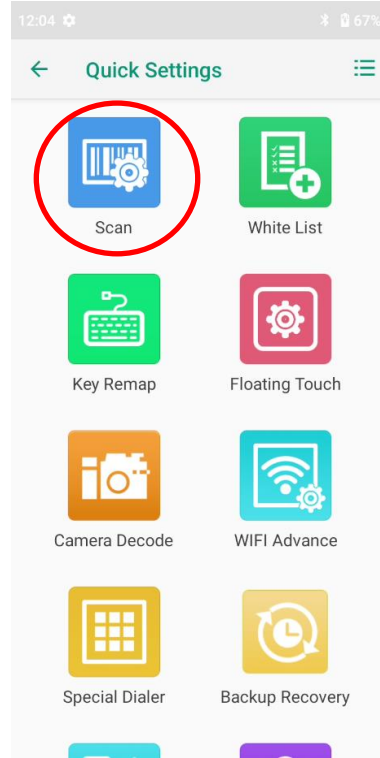
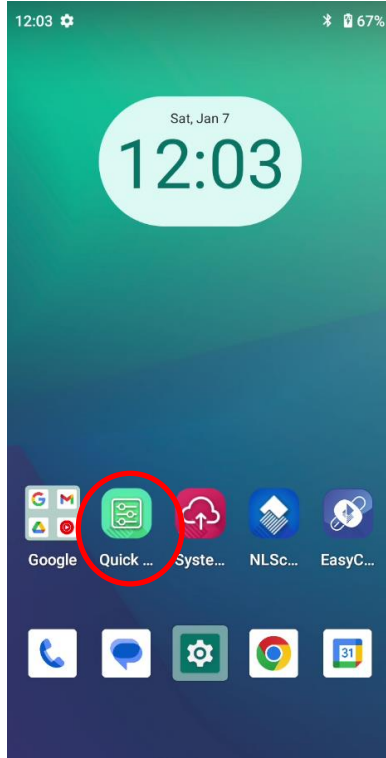

---

## Enable Scan

Check or uncheck the “Enable scan” item to enable or disable the scanning feature of the MT93.

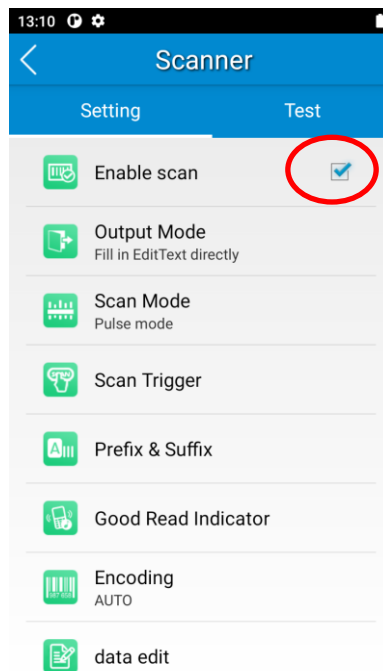

## Output Mode

The MT93 provides three output modes: Simulate keystroke, Output via API, and Fill in EditText directly.

1. **Simulate keystroke:** Output scanned data to keyboard buffer to simulate keyboard input.

Character interval (ms): A character interval of 0-100 milliseconds may be placed between the transmissions of each character of scanned data.

2. **Output via API:** Application acquires scanned data by receiving system broadcasts.

3. **Fill in EditText directly:** Output scanned data at the current cursor position in EditText.

**Overwrite output:** Clear the text input box before sending the barcode currently scanned to make sure only the most recently scanned data is present in the text input box. This feature is available only when **Simulate keystroke** or **Fill in EditText directly** is selected.

**Output enter-event:** Send an Enter Key after each barcode is scanned.

**Send virtual keyboard function:** Make send virtual keyboard function as “action done”, “action search”, “action previous”, action search, etc.

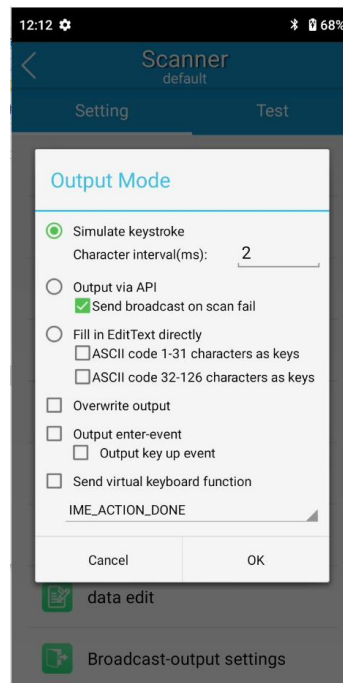
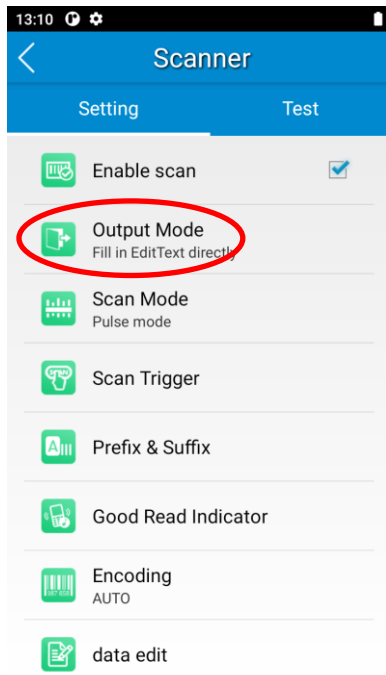

---

## Scan Mode

The MT93 provides the following four scan modes:

1. **Level mode:** Press and hold the scan trigger to start a decode session which continues until the trigger is released.
2. **Continuous mode:** Press the scan trigger to continuously read barcodes. To suspend or resume scan operation, simply press the scan trigger.

**Scan interval (ms):** This parameter sets the timeout between decode sessions.

3. **Pulse mode:** Press the scan trigger to start a decode session which continues until the decode session timeout expires.
4. **Delay mode (Scan on release key):** Press and hold the scan trigger to aim at barcode then release it to start a decode session which continues until the decode session timeout expires or a barcode is decoded. It is advised to use this scan mode and the **Acuscan Decoding** feature to ensure that only the desired barcodes are read if multiple barcodes are placed closely together.

**Decode session timeout (ms):** This parameter sets the maximum time decode session continues during a scan attempt.

**Masked repeat interval (ms):** This parameter sets the time interval between two successive reads on the same barcode.

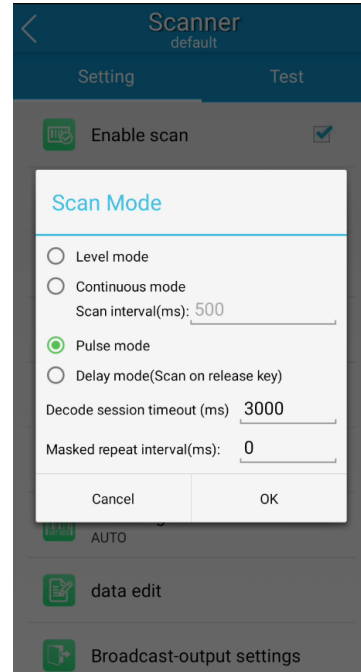
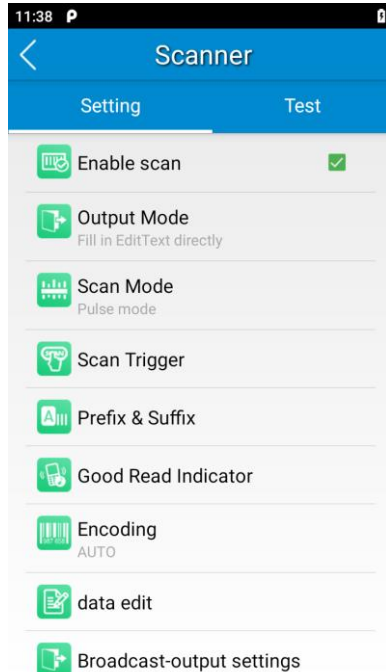

---

## Scan Trigger

The two can keys on the terminal and the trigger on the pistol grip can all serve as scan trigger. Enable or disable them as per your actual needs.

1. **Left/Right SCAN key:** Use the Scan key on the left/right side of the terminal as scan trigger.
2. **Stock SCAN key:** Use the trigger on the pistol grip attached to the terminal as scan trigger.

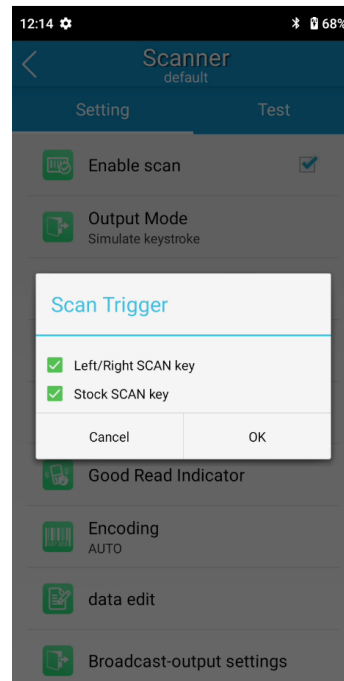
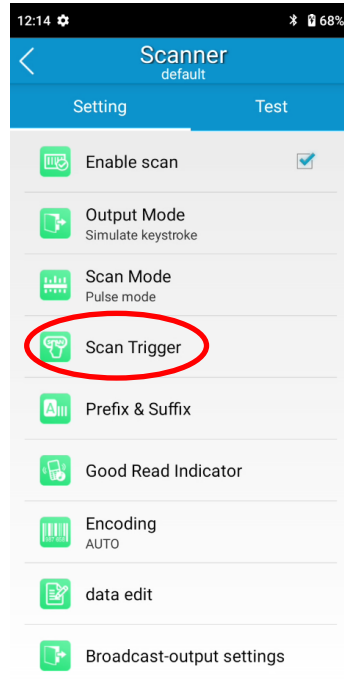

---

## Prefix & Suffix

To set the prefix/suffix, enter the hexadecimal value of a desired prefix/suffix, and then tap “OK”. For example, if you want to add a Line Feed character after each barcode, set the suffix to “0A”; if you want to add a Carriage Return character after each barcode, set the suffix to “0D”.

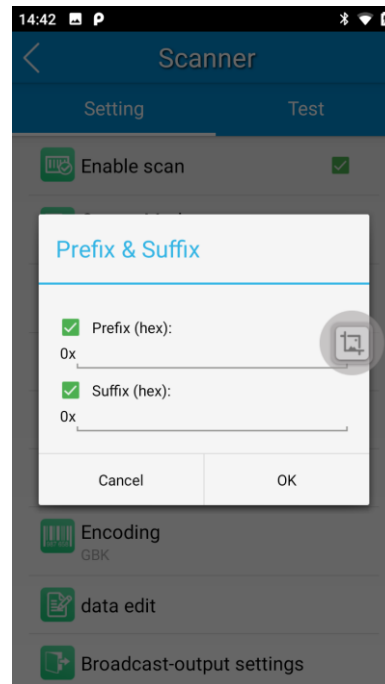
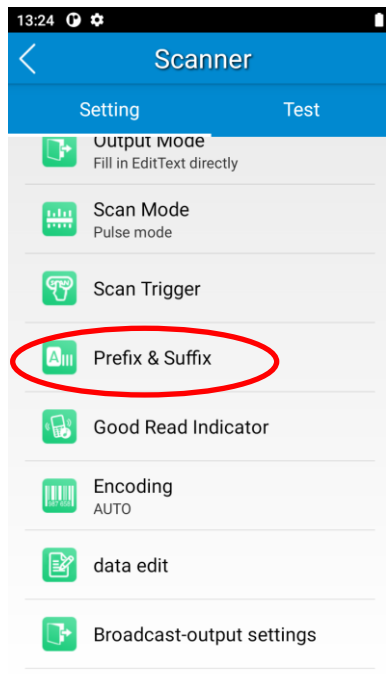

---

## Good Read Indicator

The terminal can use sound/ vibration/ LED to indicate a good read. Choose one or more options as per your actual needs.

1. **Sound:** The MT93 issues a short beep to indicate a good read.
2. **Vibrating:** The MT93 vibrates to indicate a good read.
3. **LED:** The blue LED on the MT93 flashes once to indicate a good read.

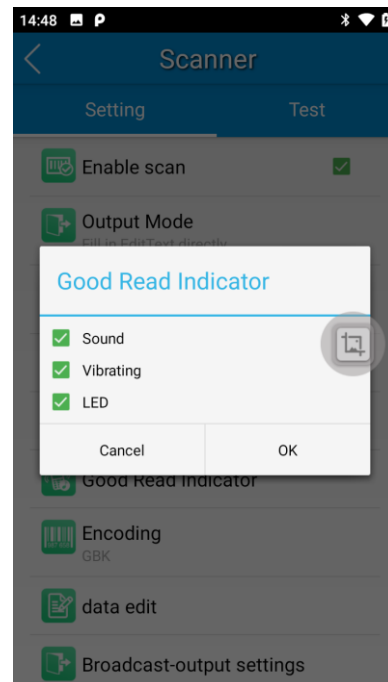
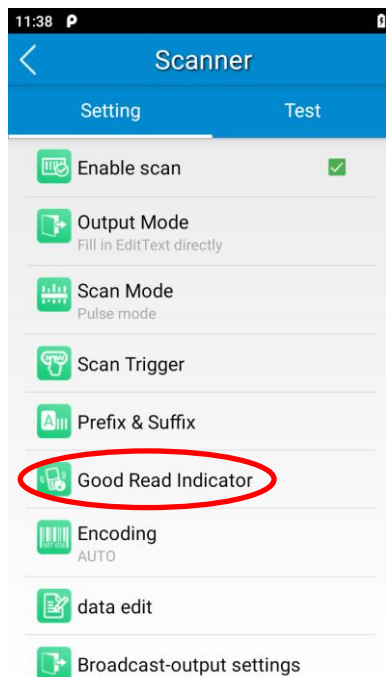

---

## Encoding

Choose a character encoding to interpret barcode data.

1. **AUTO:** The terminal determines automatically if the target barcode uses UTF-8, GBK, ISO-8859-1, or windows-1251 encoding. If the terminal produces the wrong output, you may need to choose or enter a specific character encoding.
2. **UTF-8:** Dominant Unicode encoding.
3. **GBK:** A character encoding for Chinese characters.
4. **ISO-8859-1:** A common character encoding that covers Western European languages.
5. **windows-1251:** A character encoding designed to cover language that uses the Cyrillic alphabet such as Russian, Bulgarian, Serbian Cyrillic, and other languages.
6. **Other:** Enter a different character encoding when UTF-8, GBK, ISO-8859-1, and windows-1251 are not applicable. If the terminal does not support the encoding entered, this setting will fail.

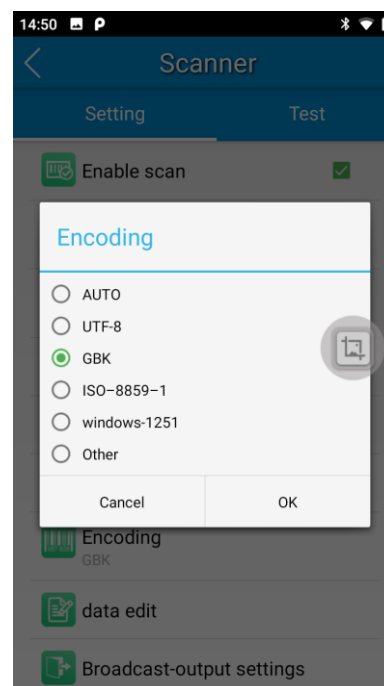
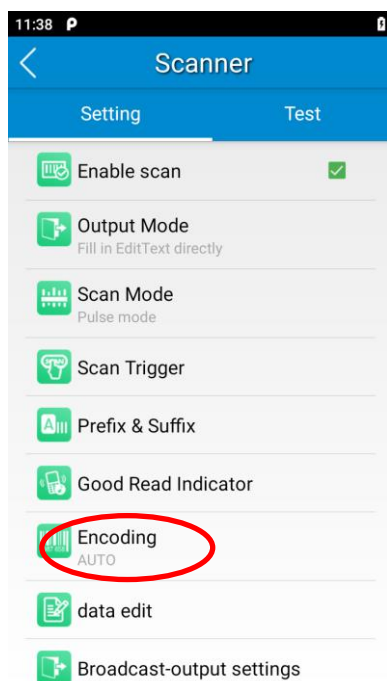



# Data Edit

This feature allows you to edit barcode data with a script.

Tap “load script” and then select the desired script file on the terminal, or scan the 2D barcode that contains a script, to load the script. Then select “exec script” and tap “OK”.

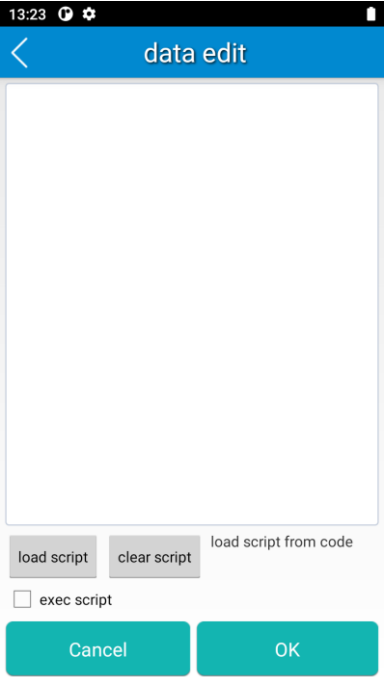
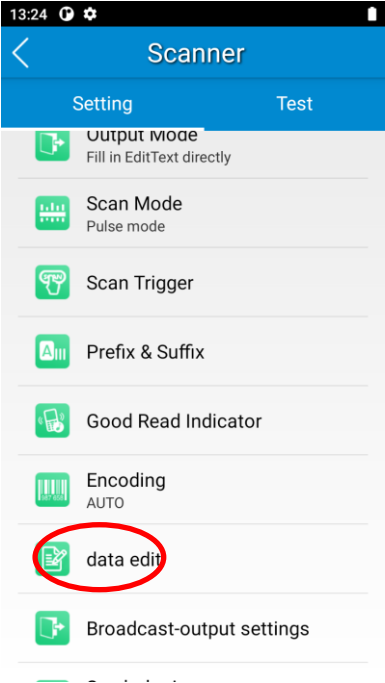

---

## Broadcast-output Settings

When using broadcast as the scan output method, the MT93 will output the scan information with the specified broadcast ACTION and EXTRA.

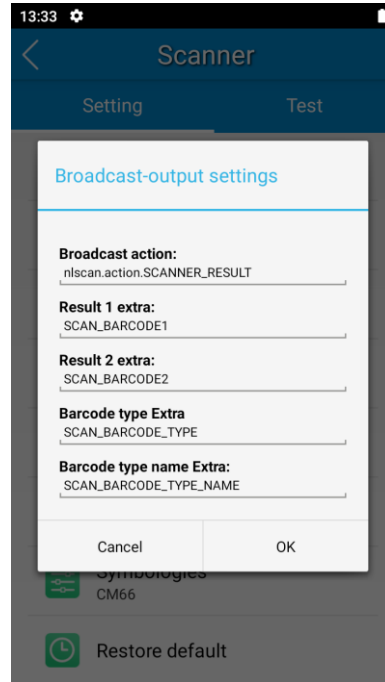
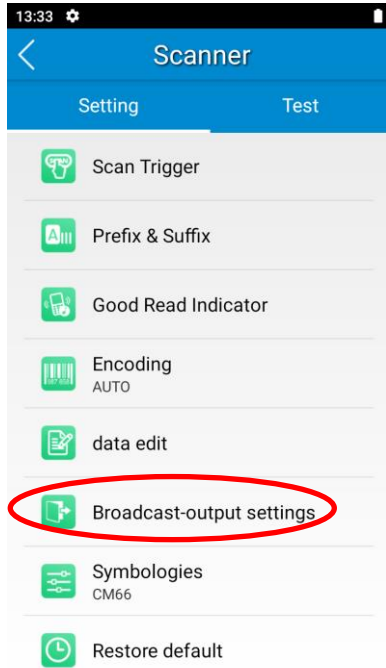

---

## Symbologies

Note that supported symbologies depend on the scan engine integrated in the terminal. Here we will take CM66 for example.

**1D code:** Enable or disable 1D symbologies and set other barcode parameters.

**Security Level:** Tap the 1D common config, then you can set the security level per actual need.

- 1) The higher the security level, the lower the error rate of code.
- 2) The barcode reading performance at the higher security level is not as smooth as that at low security. Therefore, the default security level is 1. Increase the security level only when the error rate is high.

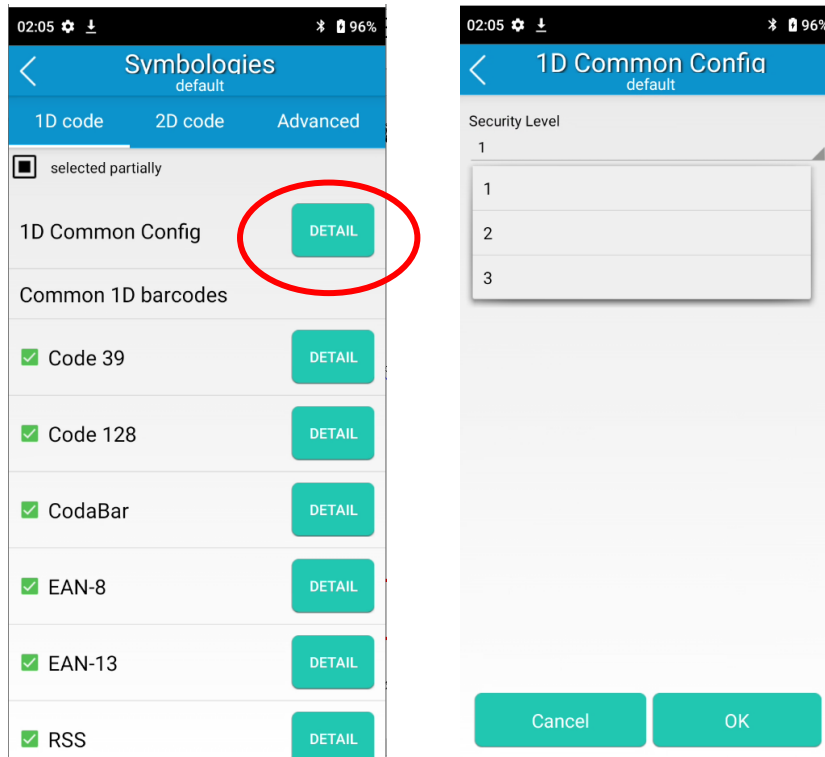

**2D code:** Enable or disable 2D symbologies and set other barcode parameters.

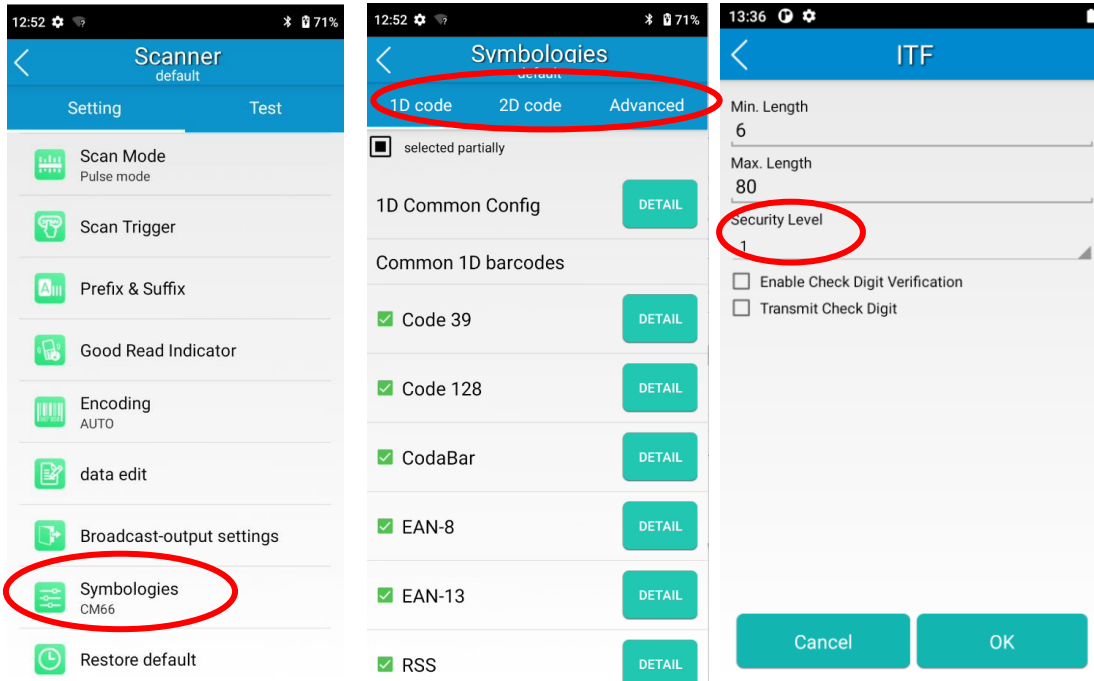

**Advanced:** The features listed here are designed to improve the scanning performance and energy efficiency of the terminal.

1. **Acuscan Decoding:** When selected, the terminal only decodes the barcode aimed squarely by the aiming pattern. It is advised to select it to ensure that only the desired barcodes are read if multiple barcodes are placed closely together.
2. **Multiple Barcodes:** When selected, the terminal can decode multiple barcodes at the same time, and the maximum number of the barcodes can be set per actual needs.
3. **Other:** Tap **DETAIL** to access the following parameter settings.

**Noise Reduction:** This feature is designed to reduce noise in images produced by the terminal. However, the terminal shows a slight decrease in scanning speed when using this feature. It is recommended to enable it only when necessary.

**Exposure Level:** Select high, middle or low level per actual need.

**Illum Mode:** Select normal or no light per actual need.

**Power Plan:** Two options are provided.

**Power Saving:** The terminal's built-in scanner turns off automatically after 3 seconds of inactivity.

**High-performance:** The terminal's built-in scanner turns off automatically after 15 seconds of inactivity.

**OCR Enable:** Select this check box when reading passports (compliant with ICAODoc9303 standards, TD1/TD2/TD3 supported).

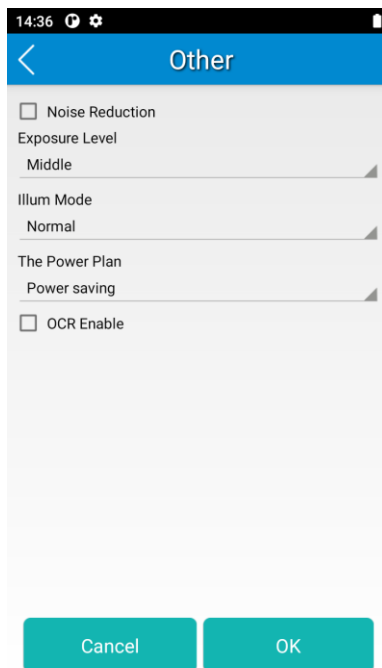
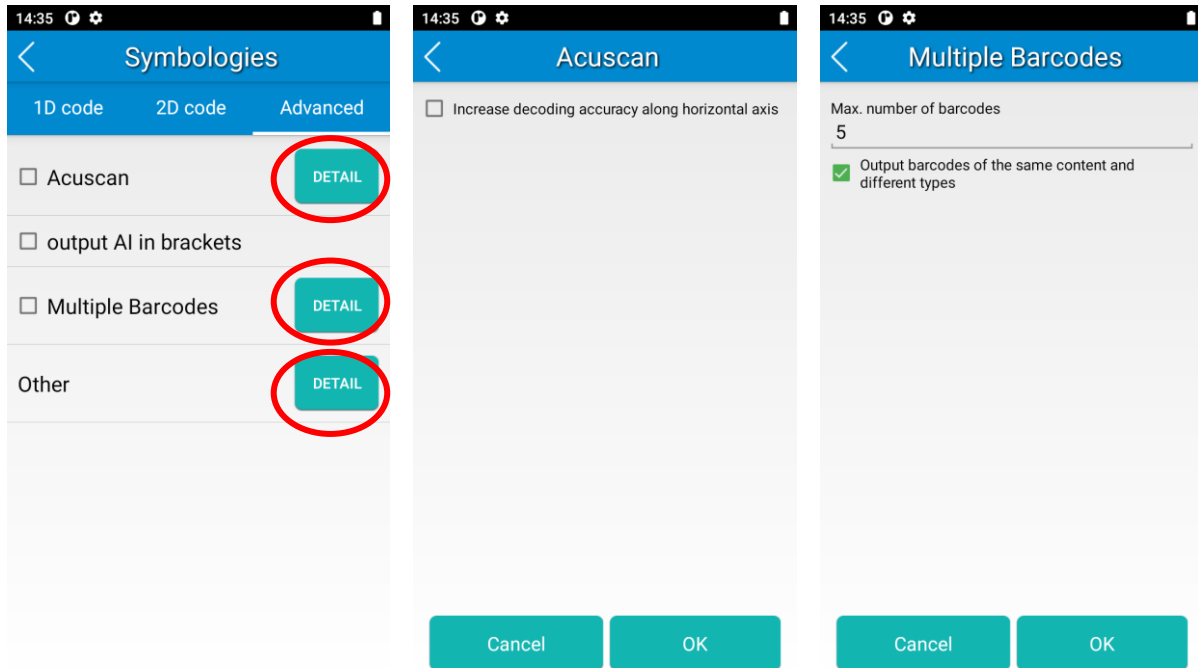

# Chapter 5 Bluetooth

## Introduction

This chapter describes how to connect the MT93 to other Bluetooth devices.

## Pair Bluetooth

You can set up a Bluetooth connection between the MT93 and other Bluetooth devices, such as PC, mobile phone. Note that the Bluetooth connection works better if there are no obstacles between them.

Before you can use a Bluetooth device with the MT93, you must first pair them.

1. Make the Bluetooth device visible to the MT93.
2. Tap the app icon  then “Connected devices” -> “Connection preferences” -> “Bluetooth”, and turn Bluetooth on to search for available Bluetooth devices.
3. Select the device from the search results to pair.
4. If prompted, input the pairing code and then tap “OK”; or if the pairing code is given automatically, then tap “PAIR”.

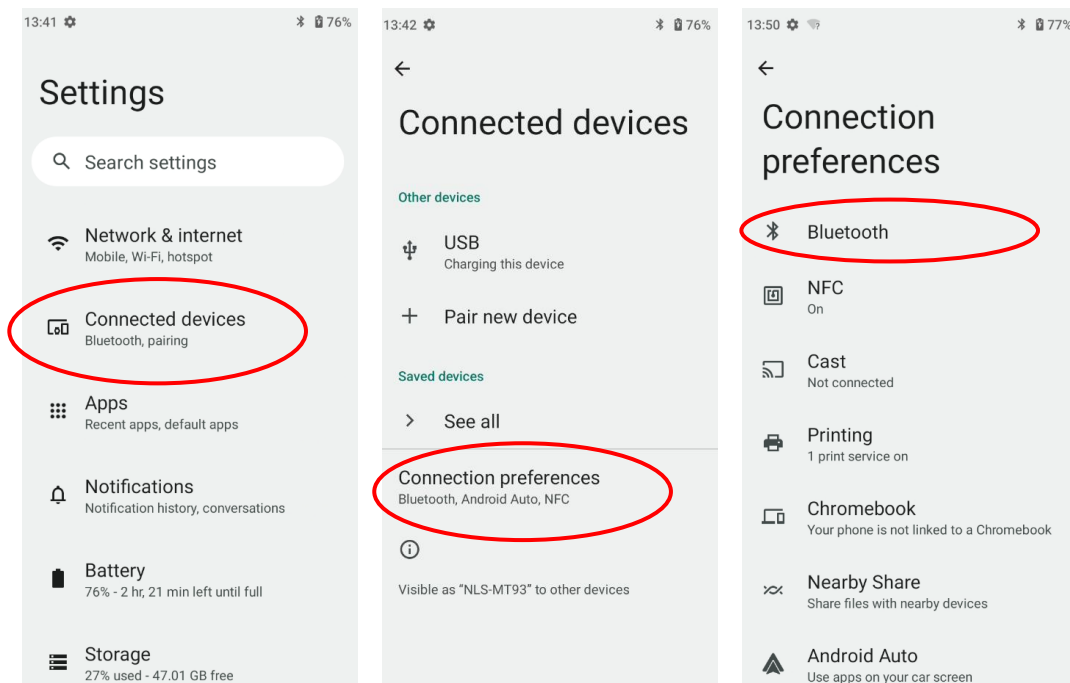

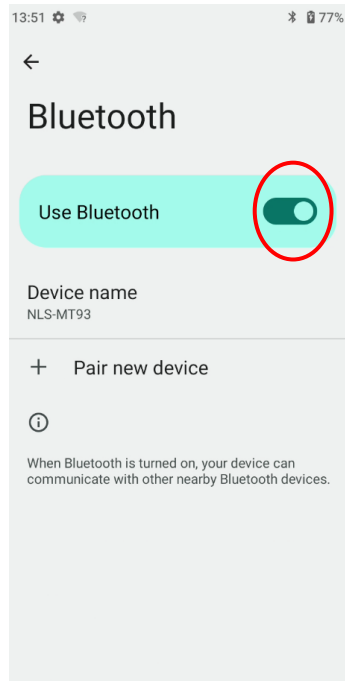

**Unpair/rename a paired Bluetooth device:** To rename the paired Bluetooth device, tap the desired device name -> then tap  to edit its name manually-> tap "RENAME". To unpair it, tap "FORGET".

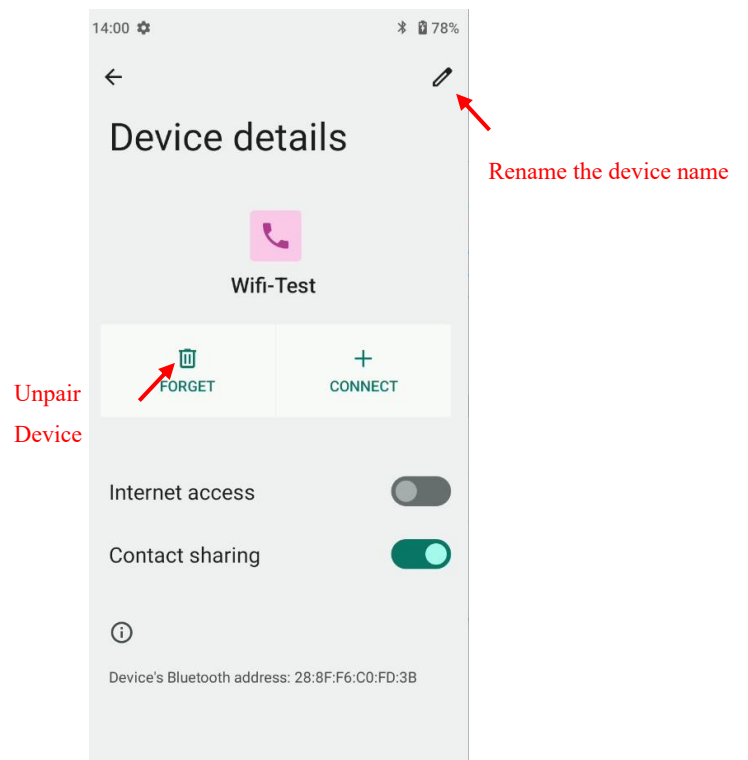
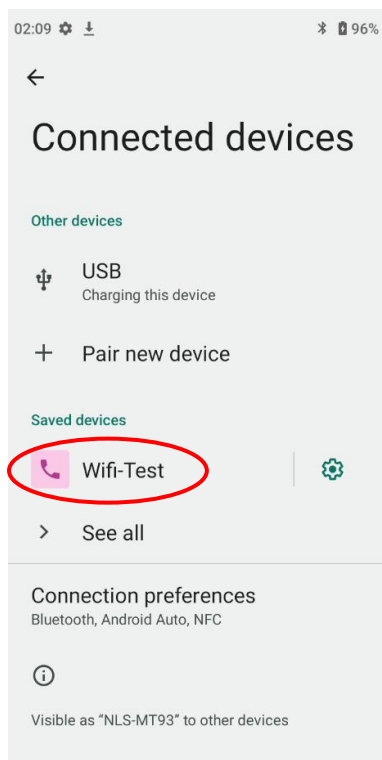

## Chapter 6 Wi-Fi

### Introduction

This chapter describes how to connect the MT93 to a Wi-Fi network.

### Join a Wi-Fi Network

1. Tap the app icon  then “Network & Internet” -> “Internet” -> “Wi-Fi”, and turn Wi-Fi on to find available Wi-Fi networks.  
If Wi-Fi is already ON, then the terminal will automatically search for available networks.
2. Tap a network and then enter the password.
3. Tap “CONNECT”.

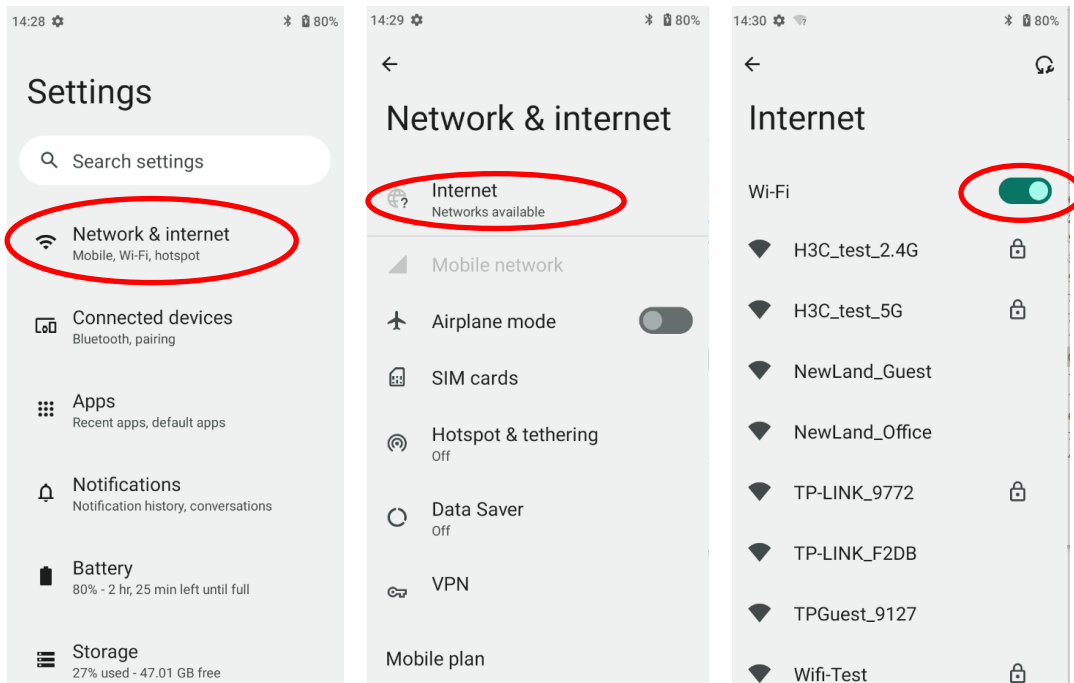



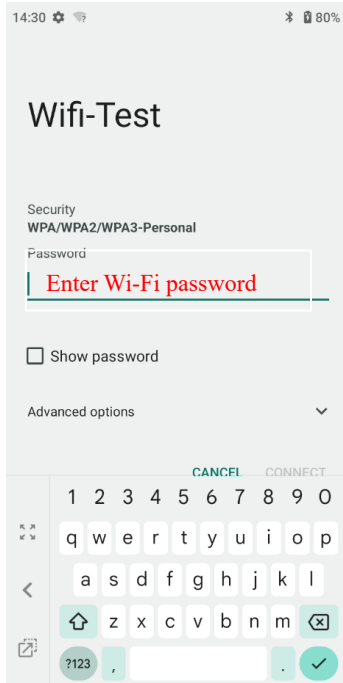

---

## WI-FI Settings

To set the “Metered”, “Proxy”, or “IP setting”, follow the first two steps of joining a Wi-Fi network, tap “Advanced options”, then select the desired option.

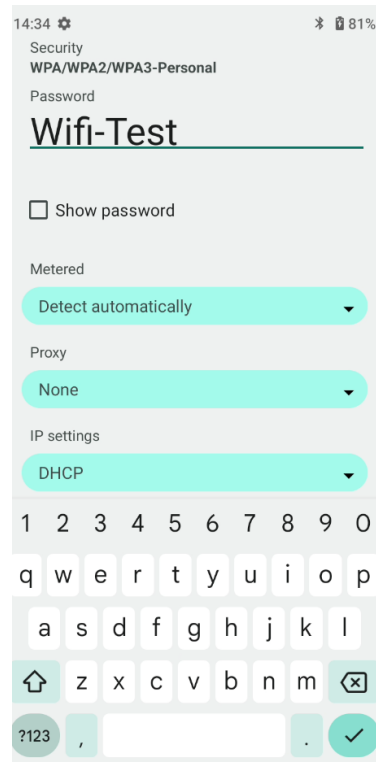
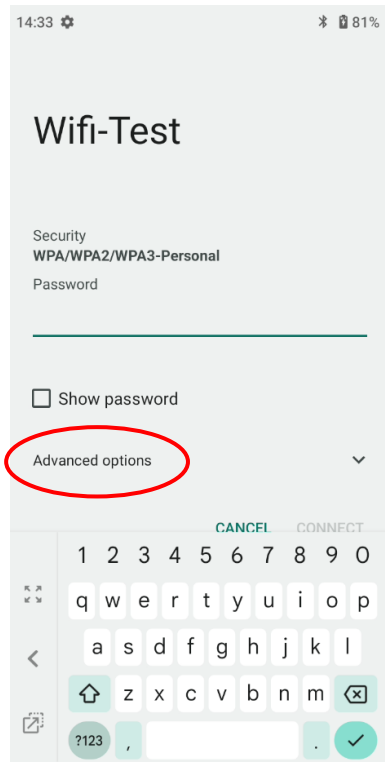

---

## Metered

“Metered” can help us better understand the Wi-Fi network data usage of MT93.

1. **Detect automatically:** Set a Wi-Fi connection as metered or unmetered automatically.
2. **Treat as metered:** Set the Wi-Fi connection to a limited data plan. You can set your connection as metered to avoid additional charges.
3. **Treat as unmetered:** Set the Wi-Fi connection to unlimited data access.

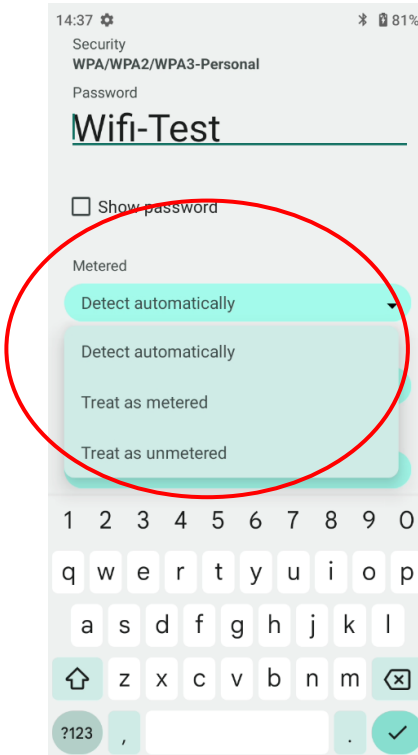

---

## Proxy

The MT93 Provides three types of Proxy: “None”, “Manual”, “Proxy Auto-Config”. To use the proxy function, you need a proxy server first. The address and port of the proxy server should be consulted with the proxy service provider.

With the “proxy” setting, you can change from **direct access** to **transit through a proxy server to access the network**. Through the network strategy of the proxy server, the firewall can enhance the privacy and security of the network.

1) **None**: No proxy.

2) **Manual**: Manually enter proxy server settings.

Following parameters are needed to be filled:

a. Proxy hostname

b. Proxy port

c. The bypass proxy for: Such as local addresses, LAN addresses.

3) **Proxy Auto-Config**: Automatically detect the appropriate settings for your network

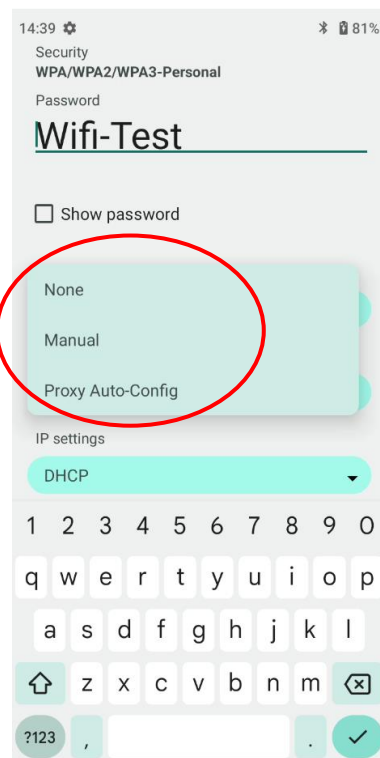

---

## IP Settings

1. Select "DHCP" to automatically obtain an IP address from the router through the DHCP service. The DHCP service should be turned on in the router, otherwise the IP address cannot be obtained.

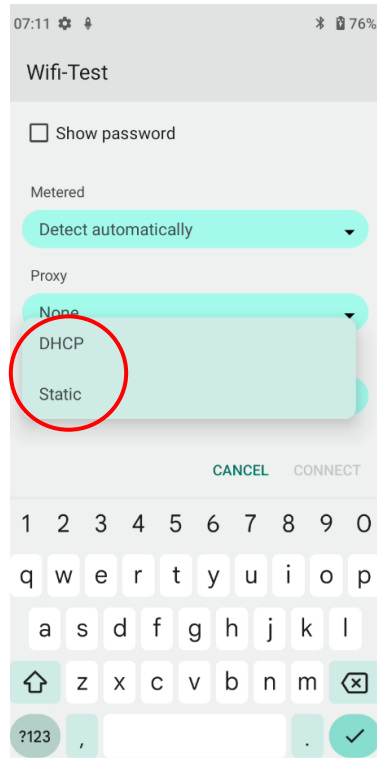

2. Select "Static" to customize the IP address. This will help to avoid the network failure caused by the duplication of the IP address in the LAN or the disable of the DHCP service in the router etc.

**Note:** To manually set a static IP address, you need to set it according to the range of IP addresses set in the router.

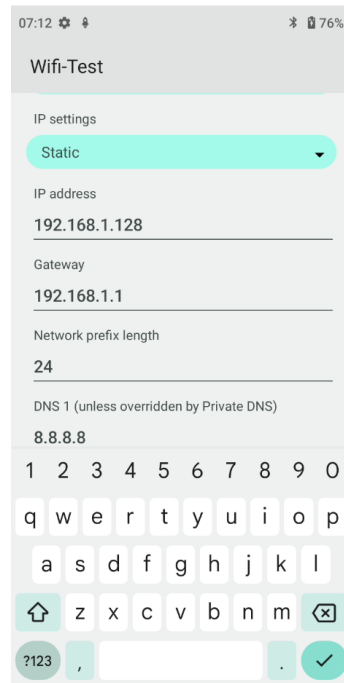
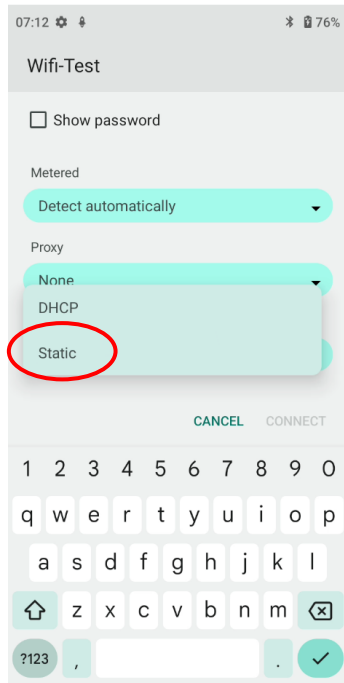

---

## Add Network

Tap the app icon  then "Network & Internet" -> "Internet" -> "Add Network". There are two methods to add network:

1. Method One: Tap  to add a network by scanning a QR code.

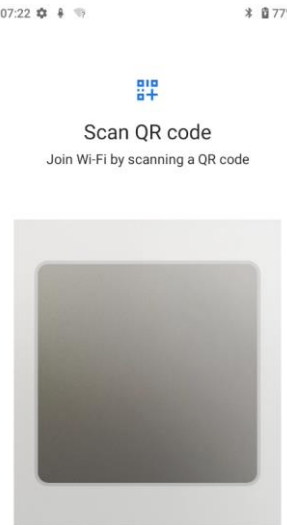
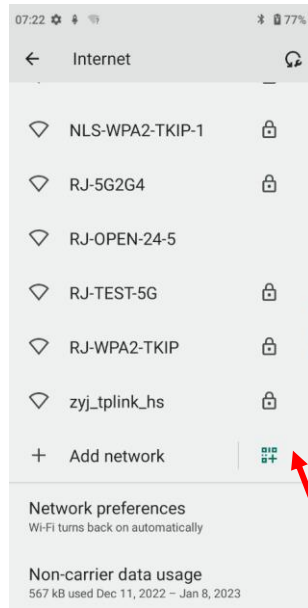

2. Method Two: Manually add network

Step 1: Tap  and fill in the network name you want to add.

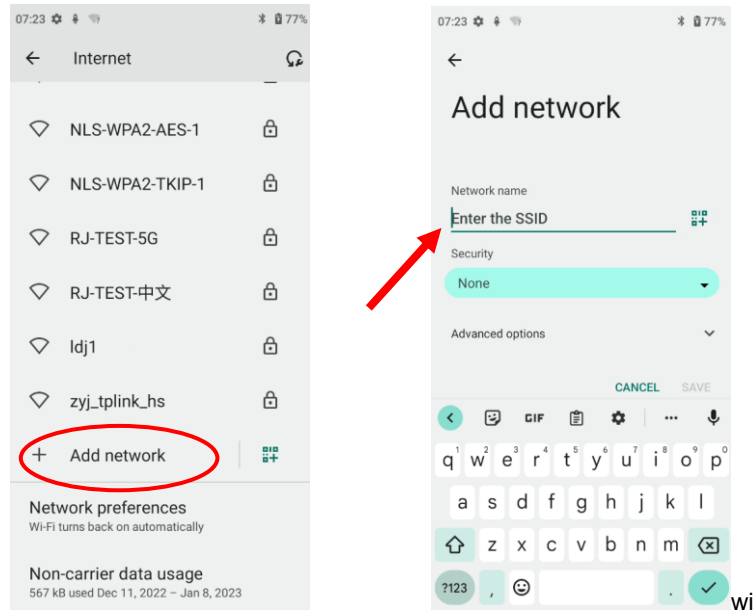

Step 2: Select the corresponding security option according to the encryption type of the router.

Supported security types: Enhanced Open, WEP, WPA/WPA2-Personal, WPA3-Personal, WPA/WPA2/WPA3-Enterprise, WPA3-Enterprise 192-bit.

Step 3: Enter the password and complete the other parameter per the actual network configuration.

Then click "Save" to complete the Wi-Fi addition.

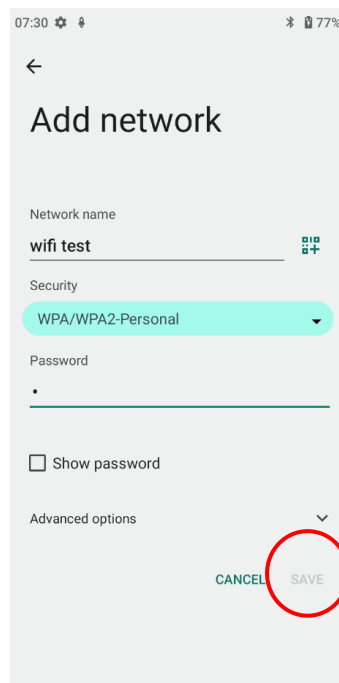



---

## Wi-Fi Preferences

Tap the app icon  then “Network & Internet” -> “Internet” -> “Network preference”, and then you can enable functions like **turn on the WI-FI automatically** and **Notify for public networks** per actual need.

- a) **“Turn on WI-FI automatically”**: Wi-Fi will automatically connect to a saved high-quality network.  
Note: To enable this function, you need to turn on the WLAN first.
- b) **“Notify for public networks”**: Notify when a high-quality public network is available.

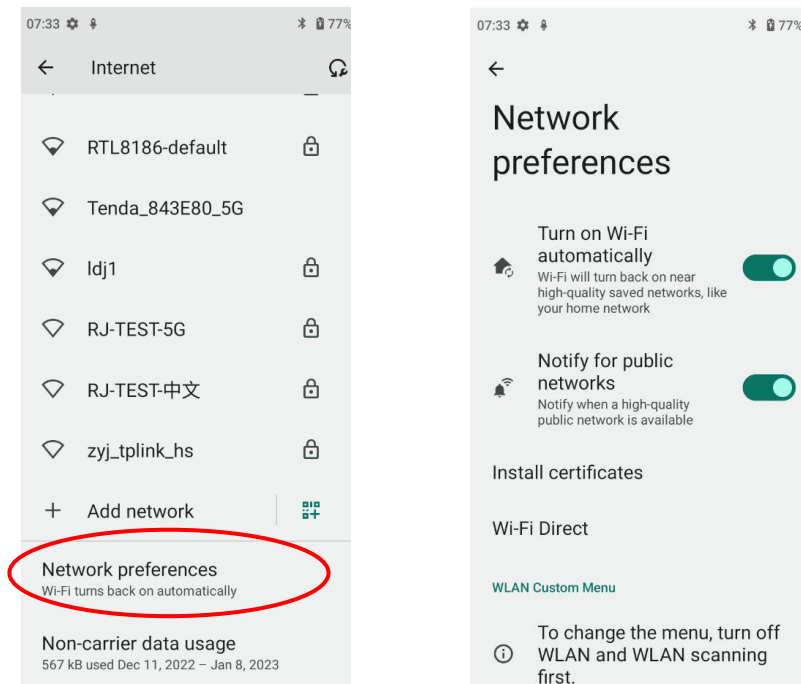

# Saved Networks

Tap the app icon  then "Network & Internet" -> "Wi-Fi" -> "Saved networks", then you can view the networks saved, or set configurations like clear, connect, and share the network per your needs.

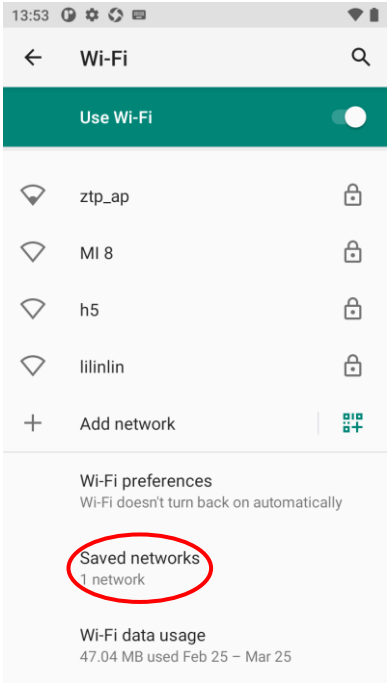

Clear the Wi-Fi

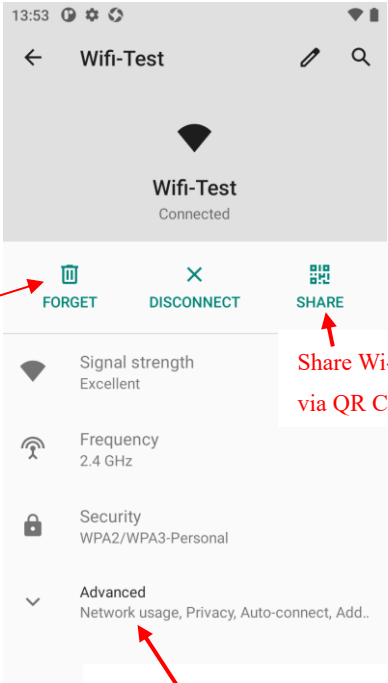

Share Wi-Fi via QR Code

Tap to add device or review network details

## Wi-Fi Data Usage

Tap the app icon  then “Network & Internet” -> “Internet” -> “Non-carrier data usage”, and then you can review the Wi-Fi data usage, including **carrier data accounting** and **APP data usage**.

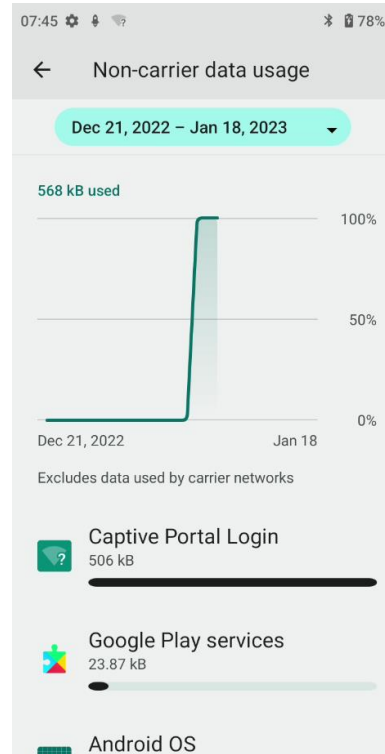
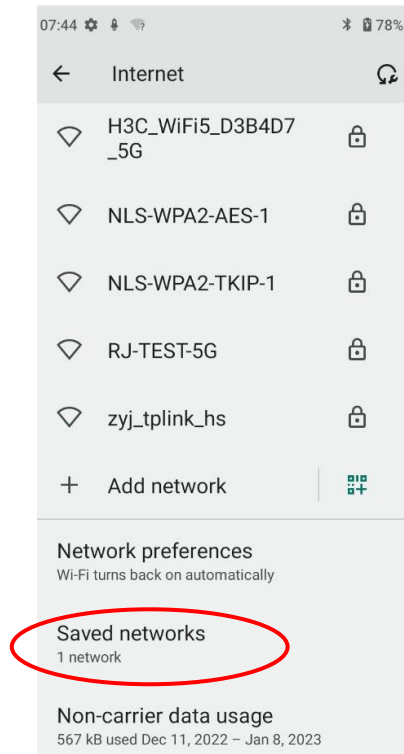

# Chapter 7 Mobile Network

## Introduction

The MT93 can also use a 4G network to connect to the internet. To establish a 4G connection, you must have a SIM card installed in your MT93.

This terminal can support 4G/3G/2G network provided by Telecom, Unicom, or Mobile

## Mobile Network Settings

If no Wi-Fi networks are available, or if you have turned Wi-Fi off, then the MT93 connects to the Internet via your cellular data network when available.

### Turn on the cellular network:

1. Swipe down from top to bottom on the home screen and it will display the drop-down list. Find mobile network and tap it to turn Cellular data on.
2. Or Go to Settings-> "Network & Internet" -> turn on "Mobile network"

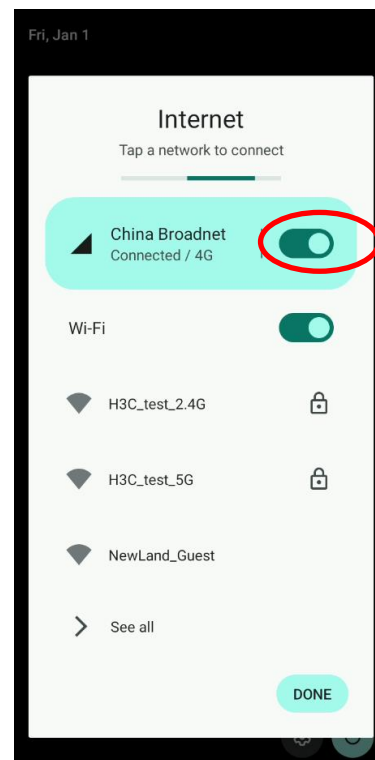
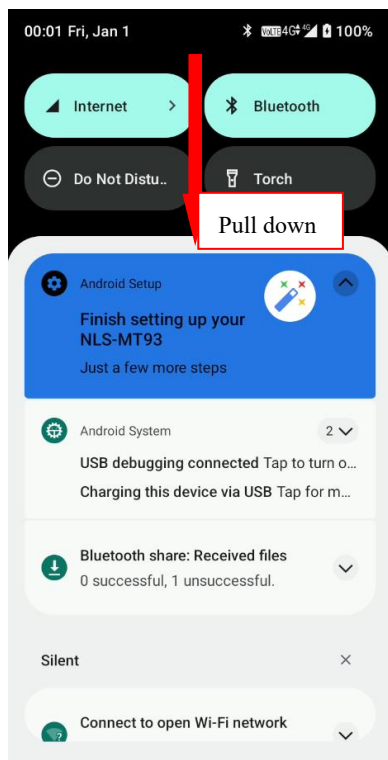

## Option Two:

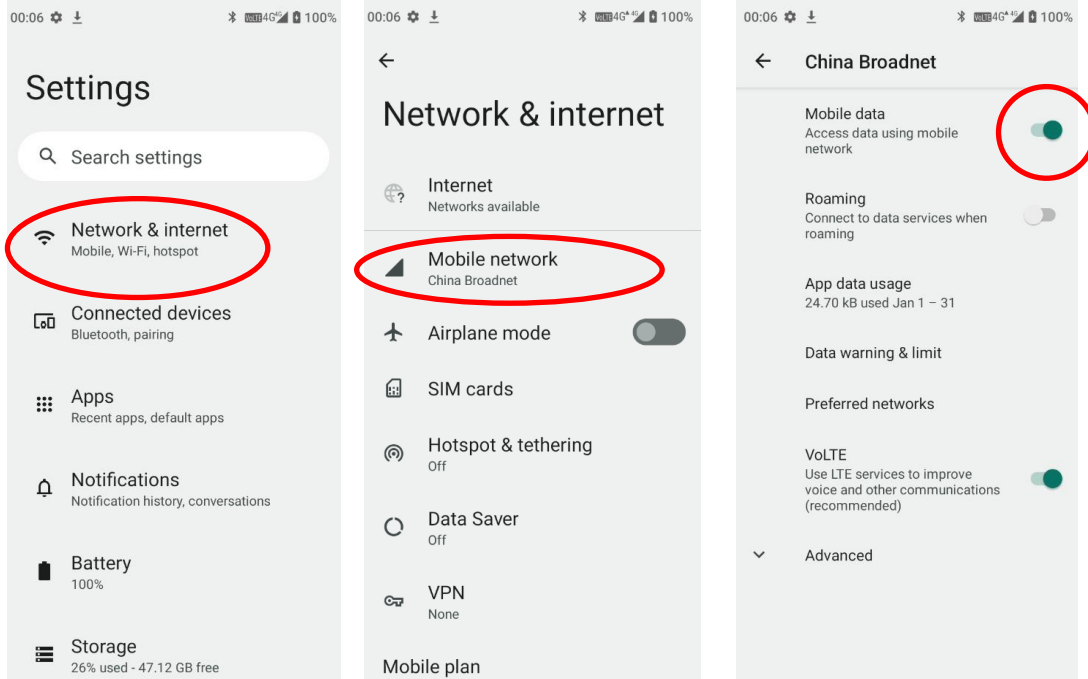



## APN Settings

If you cannot connect to the internet when using your terminal's cellular data, you may need to change your APN settings on the MT93 to fix it:

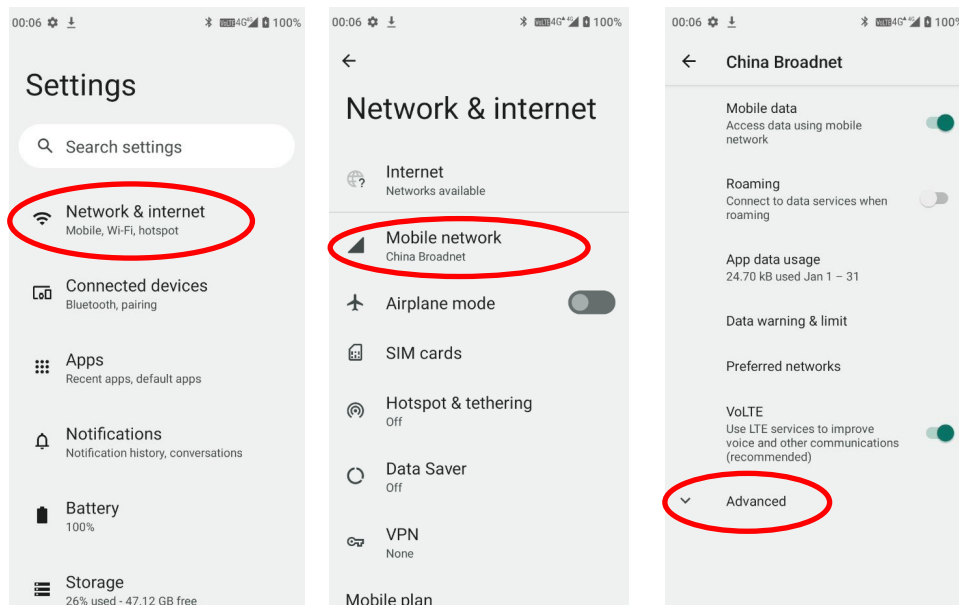
1. Go to Settings -> "Network & Internet" -> "Mobile network" -> "Advanced" -> "Access Point Names".

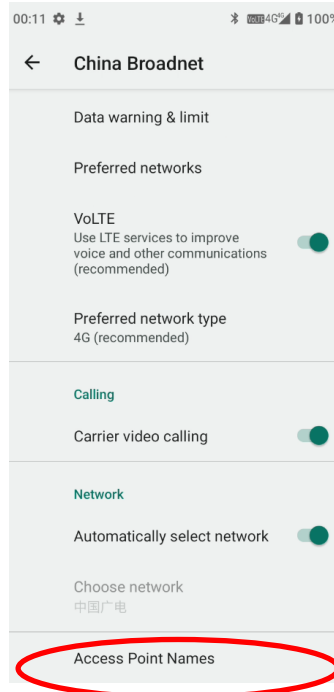



2. Tap  in the top right corner of the screen or tap the carrier of your SIM card on the screen. Then manually enter the APN settings. You can contact your carrier or visit their website to get the correct APN settings, or check the APN settings on a mobile device that can access the internet using the SIM card.

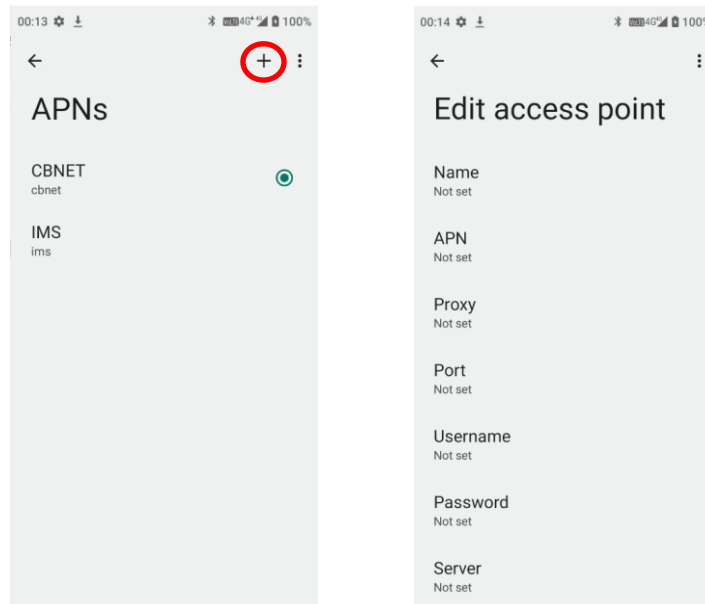



3. Press the Return key on the MT93 to go back to the previous screen and then select the APN you just added.

## Chapter 8 Others

### Camera

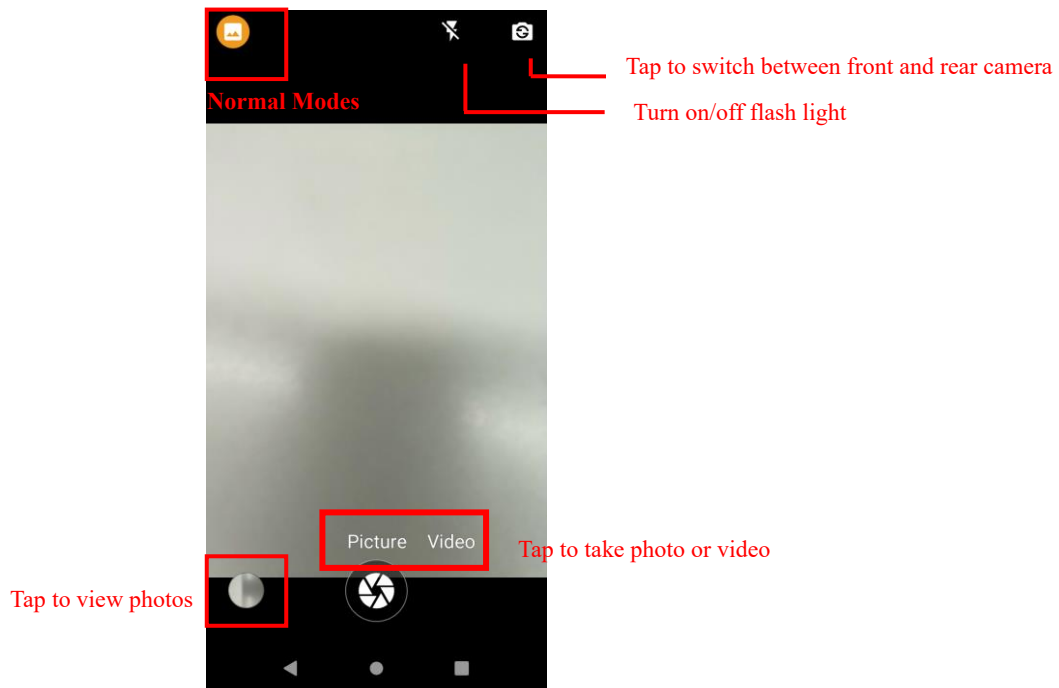
Tap the app icon  to launch the Camera app.



Tap the normal modes icon  -> Tap settings , then the user can set parameters such as scene mode, self timer, picture size, shutter sound, ZSD, white balance, ISO, Anti flicker, etc.

You can also download a camera app from the internet or develop an app for the camera feature.

## GPS

Tap the app icon  -> "Location", and then turn Location on.

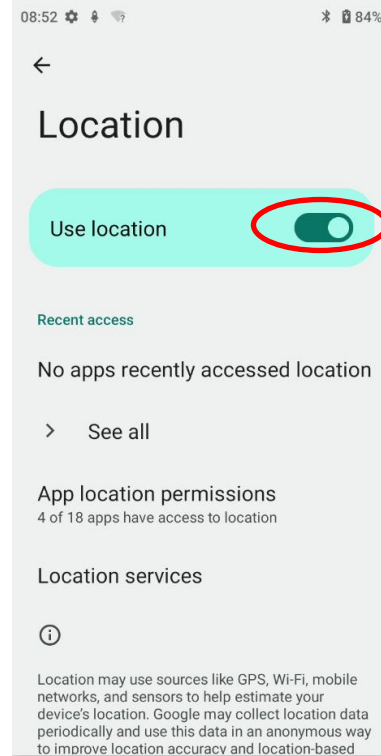
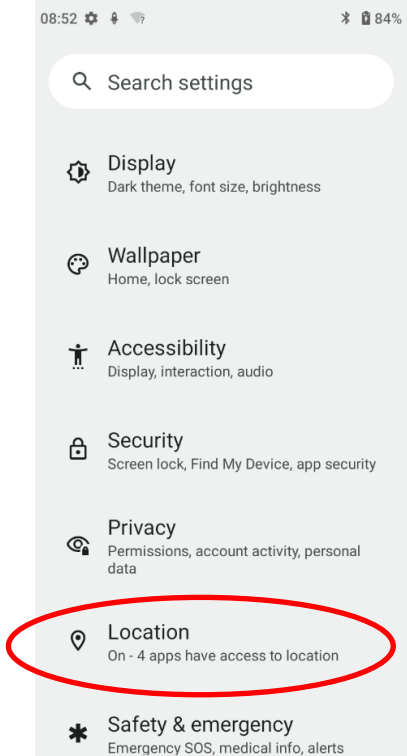



## NFC

To enable the NFC feature, tap the app icon  -> "Connected devices" -> "Connection preferences" -> "NFC", and then turn on NFC.

Then you can install an NFC writer on the MT93 to read and write NFC tags.

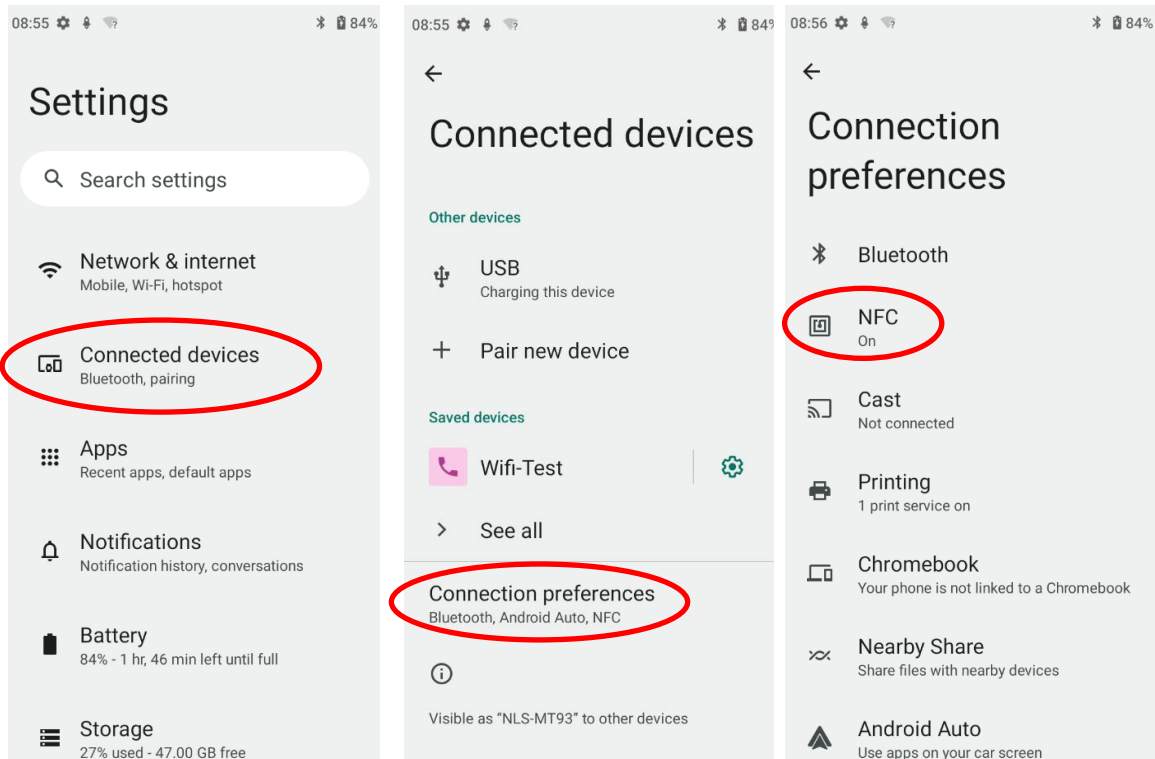



# Chapter 9 Whitelist Manager

## Introduction

The Whitelist Manager app is used to specify the apps that users can install on the MT93.

## Logging in to Whitelist Manager

Tap the app icon  on the Home screen then , enter the password (default: 112233), and tap “Login” to log in to the whitelist manager. Then set up your whitelist as per actual needs.

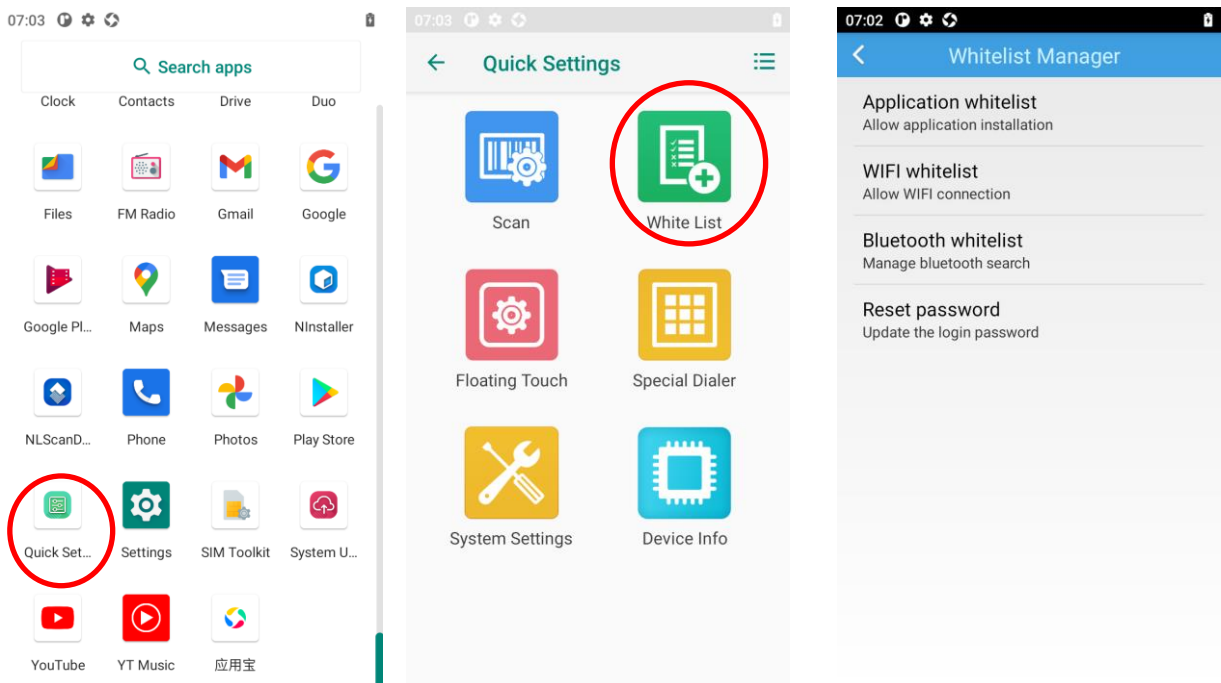

# Chapter 10 System Update

## Introduction

This chapter introduces two methods to update the system software of the terminal: Online update and local update.

## Online Update

Update the system online: Tap system updates icon  ->“CHECK FOR UPDATES”.

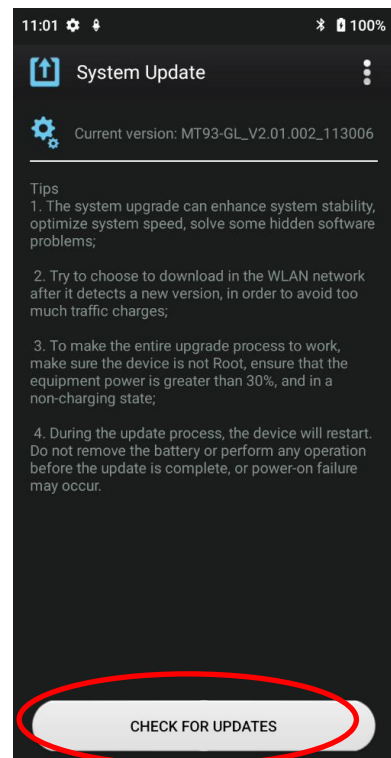
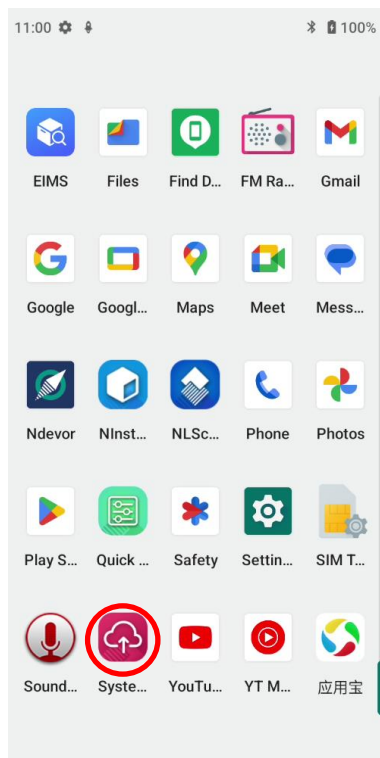

---

## Local Update

### Zip File to the MT93 Drive

1. Connect the terminal to PC with the included USB cable. Swipe from top to bottom with one finger in one smooth motion to open the notification bar. Tap “USB for file transfer”. Then select “Transfer files”.

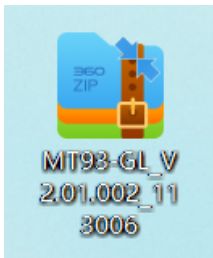

The name might be different based on each version.

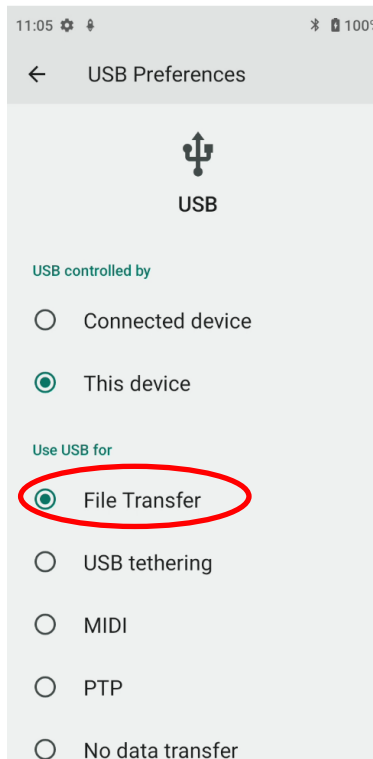

2. Copy the update zip file to the MT93 drive or MT93's Micro SD card.

3. Tap  to access the System Update screen.

4. Tap  in the top right corner of the System Update screen then select “Local Update”.

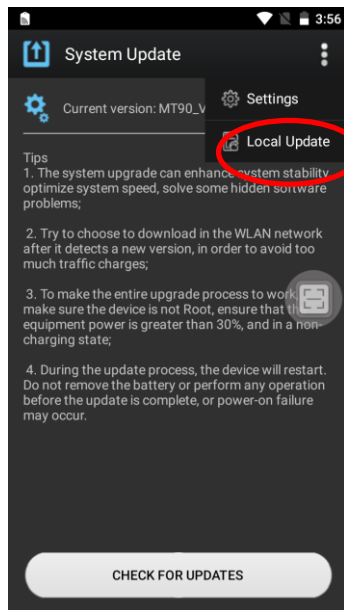

5. Select the update zip file. Then select “NEXTREBOOT” or “UPDATE”.

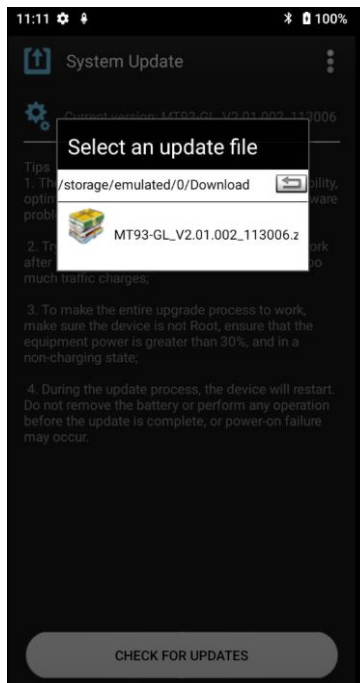

---

## Zip File to TF Card

1. Copy the update zip file to TF Card.

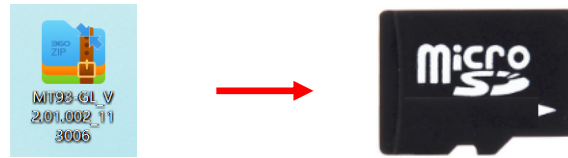

2. Insert the TF card to the MT93 and then power on the terminal.

3. Tap  to access the System Update screen.

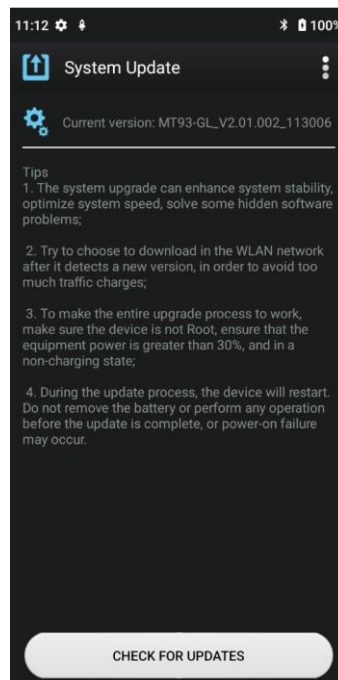

4. Tap  in the top right corner of the System Update screen, and then select "Local Update" ->"External Storage".

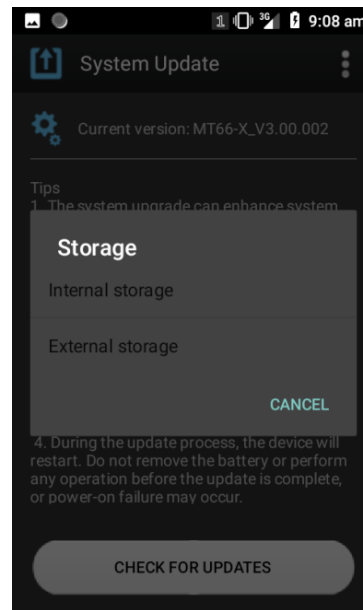
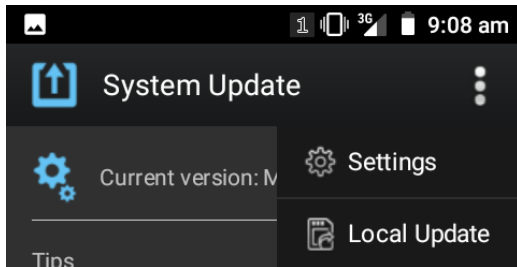

2. Select the update zip file. Then select "NEXTREBOOT" or "UPDATE".

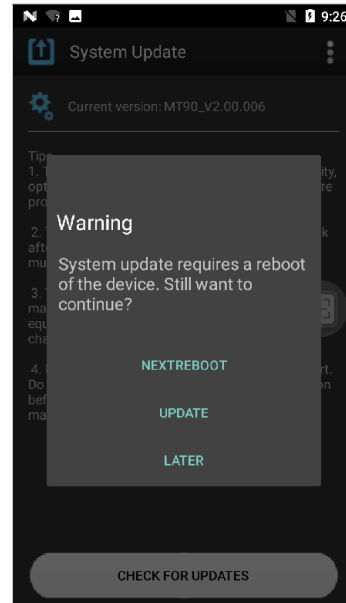

## Chapter 11 App Development Guide

### Development Environment

The MT93 runs on the Android 13 operating system, so you should use Android SDK 13 or lower when developing apps for the MT93.

### Use of Non-standard Interfaces

See *Newland Android PDA API Handbook*.



# Chapter 12 Maintenance & Troubleshooting

## Introduction

This chapter includes important safety and handling information and provides troubleshooting solutions for issues that might occur when using the terminal.

## Important Safety & Handling Information

### Disassembly and Retrofit

Do not attempt to disassemble or retrofit the terminal yourself. Unauthorized disassembly or retrofit will void the warranty.

### External Power Supply

Use only the included AC adapter. Otherwise, there is a risk of damage to the terminal.

### Abnormal Situation

Keep the terminal away from fire or heat sources. If there is unusual odor, overheating or smoke during charging, immediately cut off the power and disconnect the AC adapter, and contact your dealer or Newland customer service center. Continued use in this case may result in fire or electric shock.

### Drop Damage

If the terminal is damaged due to a drop from high place, immediately cut off the power and contact your dealer or Newland customer service center.

### LCD Screen

Do not press against or strike the LCD screen. Otherwise, it may damage the screen. When handling a cracked or shattered screen, do not touch the liquid that has leaked from it to avoid skin burn or infection.

### Stacking Heavy Objects

Do not place heavy objects on the terminal as those objects may fall and cause injury.

### Mounting Location

Do not place the terminal on unstable or uneven surfaces as it may fall and cause injury. Do not expose the terminal to humidity or dust as this may cause fire or electric shock. Do not expose the terminal to direct sunlight for extended periods.

---

## Wireless Functionalities

Do not use the terminal's wireless functionalities where wireless device use is prohibited or where it may cause interference or danger, such as in aircrafts, petrol stations.

## Use & Maintenance

- ✧ If the terminal cannot be switched on after experiencing a sudden or unexpected power loss or other abnormalities, remove and then reinstall its battery to reset the terminal.
- ✧ Do not throw, drop or strike the terminal. Doing so may damage the LCD display, interrupt running programs, cause data loss in memory and result in malfunction.
- ✧ Clean the scan window regularly. Do not touch it with hands. Scratched or smudged window may degrade reading performance.
- ✧ Do not tap the touch screen with sharp objects. Doing so may damage the screen or cause internal short circuits.
- ✧ Use only a dry soft cloth to clean the terminal. Cleaning it with wet cloth or benzene/ thinner/ other volatile chemicals may deform and shorten the service life of the keypad and shell of the terminal.
- ✧ Do not place the terminal face down on any surface, or there might be misoperations.
- ✧ Sudden temperature drops may cause condensation on the shell which could cause malfunction. Care should be taken to avoid condensation. If condensation occurs, dry the terminal before use.

## Battery Safety Guidelines

- ✧ **Do not dispose of batteries in a fire as they may explode.**
- ✧ The battery can be charged and discharged over 500 times. If the battery life is unreasonably short, please replace the battery with a new one.
- ✧ Use only the battery and AC adapter provided by Newland.
- ✧ Do not continue to charge a battery that is fully charged. Overcharging will shorten battery lifespan.
- ✧ Charge the device before the battery is exhausted; Excessive battery discharge will have a bad impact on the device. In severe cases, it may cause the device to fail to boot normally.
- ✧ Avoid charging in a low or high-temperature environment. The most suitable temperature for charging is at 5°C–45°C (41°F–113°F), and it cannot be charged below 0°C (32°F).
- ✧ If the device is not used for a long time, it will discharge slowly. During the storage, it is recommended to shut down the device and regularly recharge it (at least every six months). Ideally, Battery should be stored between 30% to 50% state of charge.

- 
- ✧ Do not use damaged or faulty AC adapters or batteries. If the battery is swelling, bulging, or having other abnormalities, please stop using it immediately.
  - ✧ **Properly dispose of and recycle batteries. Do not dispose of them as household garbage.**

## Troubleshooting

Problem		Possible Cause & Solution
Type	Description	
Battery	Charging LED is OFF when charging.	Ensure the AC adapter is plugged in properly.
	Stop charging or charging slowly in a low-temperature environment.	Charging protection is enabled when the temperature is lower than 0 degrees Celsius. To continue charging at normal speeds, please move to a warmer environment before charging your device.
	Noticeably short battery life.	<ol style="list-style-type: none"> <li>1. Check the battery level. If the battery is almost depleted, recharge it.</li> <li>2. Restart the terminal, if the problem remains, please contact the after-sales service center.</li> </ol>
	Fully charged battery is depleted after the terminal is switched on.	Restart the terminal, if the problem remains, please contact the after-sales service center.
USB	USB communication failure	<ol style="list-style-type: none"> <li>1. Ensure that the USB cable connections are secure.</li> <li>2. Ensure that there is no contaminant inside the USB port.</li> <li>3. If the problem remains, please contact the after-sales service center.</li> </ol>
LCD Screen	No display	<ol style="list-style-type: none"> <li>1. Ensure the terminal is switched on.</li> <li>2. If the terminal is in sleep mode, press the Power key to wake it up.</li> <li>3. Check the battery level. If the battery is depleted, recharge it.</li> <li>4. If the problem remains, please contact the after-sales service center.</li> </ol>
System	Cannot switch on	<ol style="list-style-type: none"> <li>1. Check the battery level. If the battery is depleted, recharge it.</li> <li>2. Switch the terminal on after using the included AC adapter to connect it to a power outlet. If the problem disappears, then continue to charge the terminal. If the problem remains after charging the terminal for a while, please contact the after-sales service center.</li> </ol>
	System halted	<ol style="list-style-type: none"> <li>1. The problem may be caused by bugs on downloaded apps. Ensure that only reliable apps are used.</li> <li>2. The problem may be caused by a sudden or unexpected power loss. Long press the power key for 10 seconds, and then restart the terminal.</li> <li>3. If the problem remains, please contact the after-sales service center.</li> </ol>

**Newland EMEA**  
+ 31 (0) 345 87 00 33  
[info@newland-id.com](mailto:info@newland-id.com)

Rolweg 25  
4104 AV Culemborg  
The Netherlands

**Need more info?**  
Contact us or one of our partners at  
[newland-id.com/contact](https://newland-id.com/contact)

